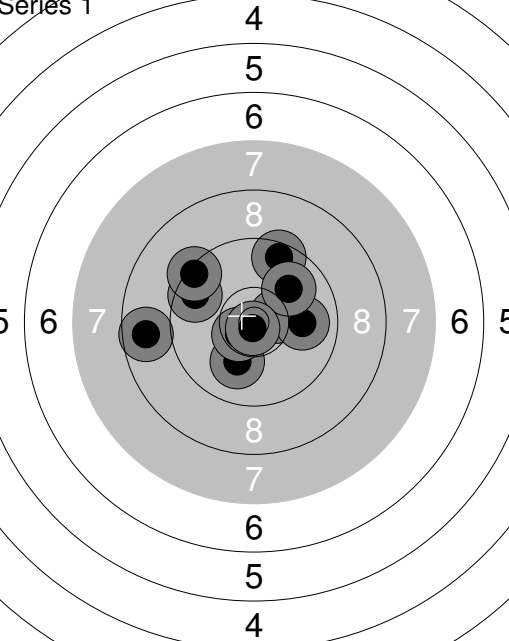
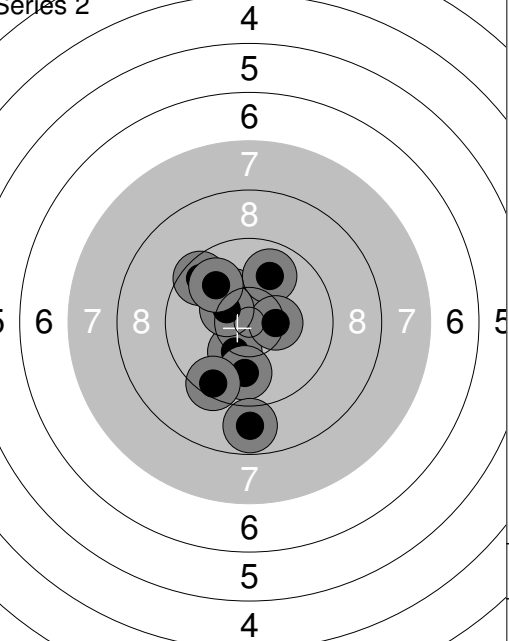
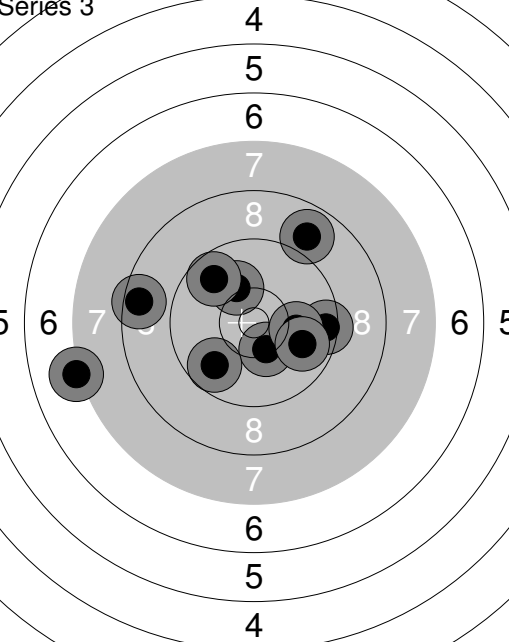
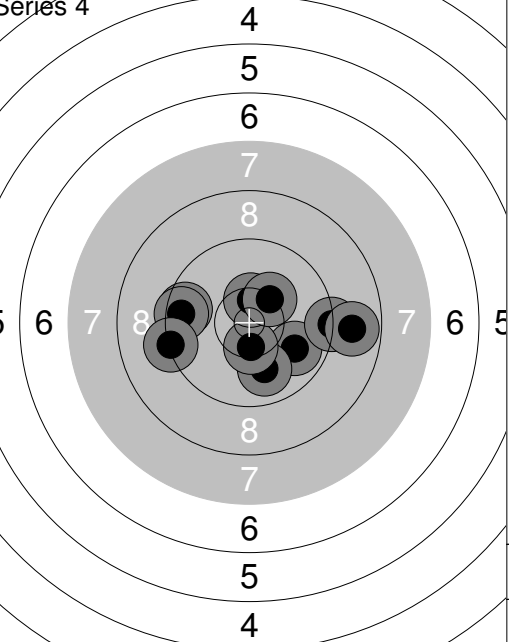
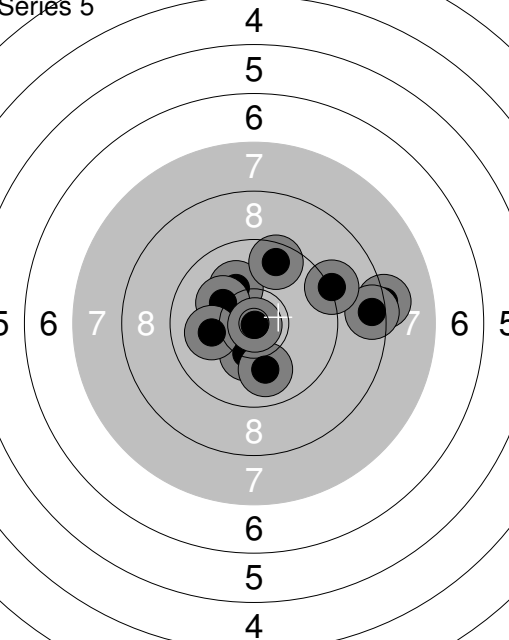
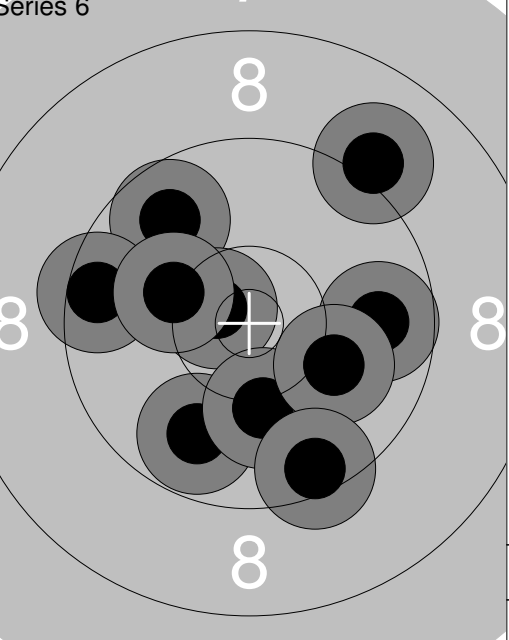
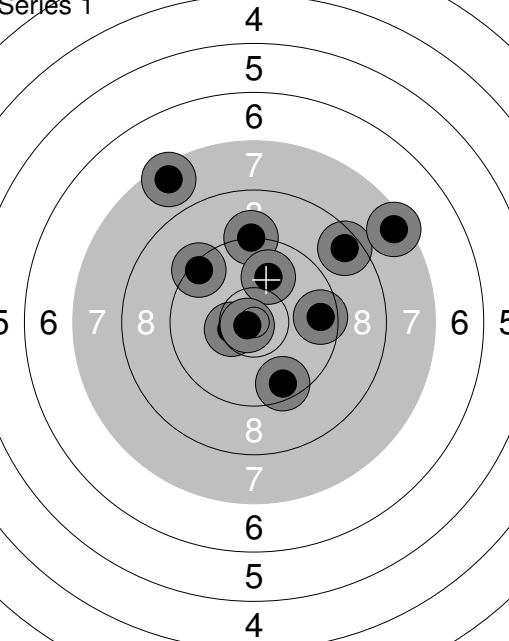
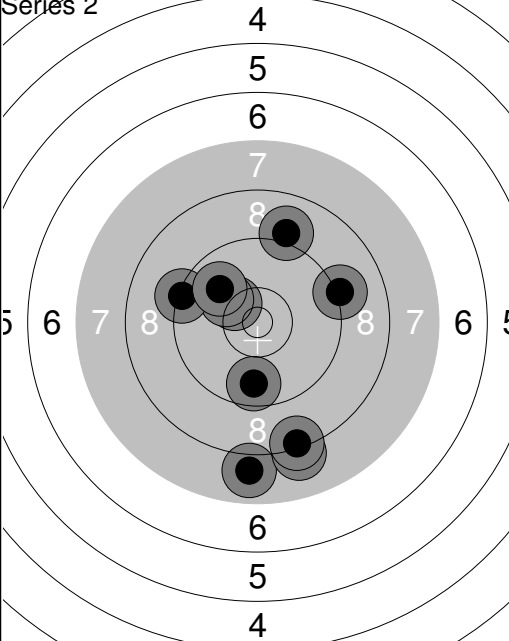
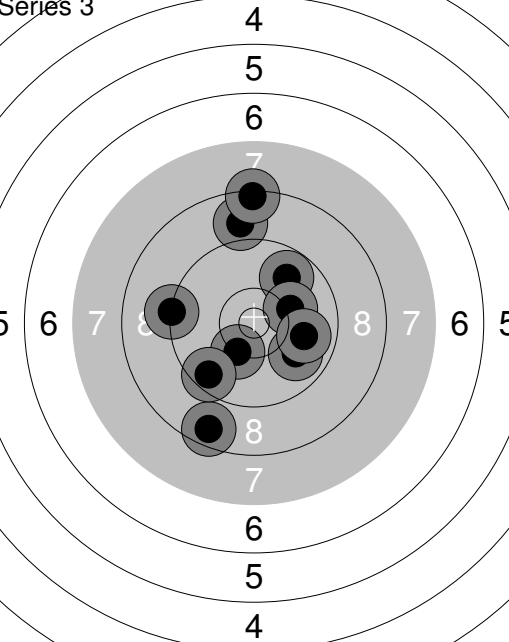
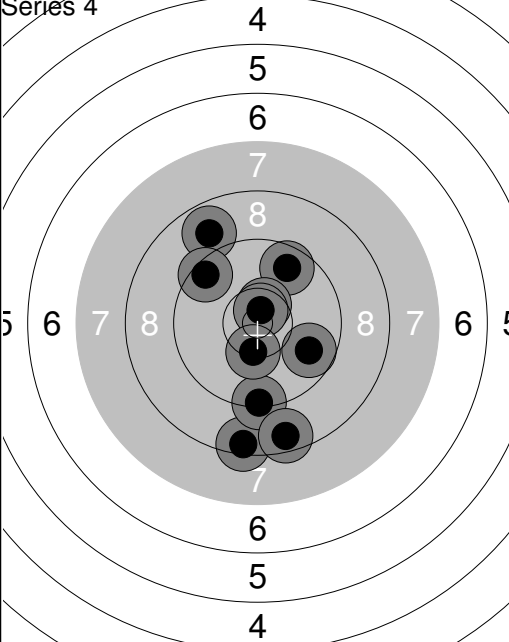

<p>Series 1</p> 	<p>1: 9.5 ↗</p> <p>2: 10.1 ↓</p> <p>3: 10.5x →</p> <p>4: 10.5x ↙</p> <p>5: 9.6 ↖</p> <p>6: 8.7 ←</p> <p>7: 10.0 →</p> <p>8: 10.0 ↗</p> <p>9: 10.8x ↓</p> <p>10: 9.4 ↖</p>	<p>Series 2</p> 	<p>11: 10.3 ↖</p> <p>12: 9.9 ↗</p> <p>13: 10.3 ↙</p> <p>14: 9.9 ↓</p> <p>15: 10.4x →</p> <p>16: 8.8 ↓</p> <p>17: 10.4x ↖</p> <p>18: 9.6 ↖</p> <p>19: 9.5 ↓</p> <p>20: 9.9 ↖</p>
	Series 99.1		Series 99.0
	Total 99.1		Total 198.1

<p>Series 3</p> 	<p>21: 8.5 ←</p> <p>22: 10.4 ↓</p> <p>23: 10.1 ↗</p> <p>24: 8.9 ↗</p> <p>25: 7.2 ←</p> <p>26: 9.5 →</p> <p>27: 9.7 ↗</p> <p>28: 10.1 →</p> <p>29: 9.9 →</p> <p>30: 9.8 ↙</p>	<p>Series 4</p> 	<p>31: 9.9 ↘</p> <p>32: 10.0 ↓</p> <p>33: 10.5x ↓</p> <p>34: 9.6 ←</p> <p>35: 9.5 ←</p> <p>36: 9.3 →</p> <p>37: 10.5x ↑</p> <p>38: 8.8 →</p> <p>39: 9.3 ←</p> <p>40: 10.3 ↗</p>
	Series 94.1		Series 97.7
	Total 292.2		Total 389.9

<p>Series 5</p> 	<p>41: 10.1 ↗</p> <p>42: 10.2 ↖</p> <p>43: 9.6 ↗</p> <p>44: 10.3 ↓</p> <p>45: 8.2 →</p> <p>46: 10.1 ←</p> <p>47: 8.5 →</p> <p>48: 9.2 →</p> <p>49: 10.0 ↓</p> <p>50: 10.9x ↓</p>	<p>Series 6</p> 	<p>51: 9.7 ↖</p> <p>52: 9.1 ↗</p> <p>53: 9.5 ←</p> <p>54: 9.8 →</p> <p>55: 9.8 ↓</p> <p>56: 10.6x ↖</p> <p>57: 10.2 ↓</p> <p>58: 10.2 ↖</p> <p>59: 10.1 →</p> <p>60: 9.5 ↓</p>
	Series 97.1		Series 98.5
	Total 487.0		Total 585.5

<p>Series 1</p> 	<p>1: 9.6 →</p> <p>2: 8.5 ↗</p> <p>3: 9.6 ↓</p> <p>4: 9.2 ↑</p> <p>5: 7.5 ↗</p> <p>6: 10.0 ↑</p> <p>7: 10.5x ←</p> <p>8: 10.8x ←</p> <p>9: 7.5 ↖</p> <p>10: 9.4 ↖</p>	<p>Series 2</p> 	<p>11: 7.9 ↓</p> <p>12: 8.1 ↓</p> <p>13: 10.3 ↗</p> <p>14: 10.2 ↗</p> <p>15: 8.3 ↓</p> <p>16: 9.3 ↖</p> <p>17: 9.9 ↗</p> <p>18: 9.7 ↓</p> <p>19: 9.2 →</p> <p>20: 9.0 ↑</p>
	Series 92.6		Series 91.9
	Total 92.6		Total 184.5

<p>Series 3</p> 	<p>21: 8.9 ↑</p> <p>22: 10.3 ↓</p> <p>23: 9.2 ←</p> <p>24: 9.9 →</p> <p>25: 9.8 ↗</p> <p>26: 8.6 ↓</p> <p>27: 10.1 →</p> <p>28: 9.5 ↖</p> <p>29: 8.3 ↑</p> <p>30: 9.9 →</p>	<p>Series 4</p> 	<p>31: 9.7 ↗</p> <p>32: 8.4 ↓</p> <p>33: 8.8 ↖</p> <p>34: 9.5 ↖</p> <p>35: 9.3 ↓</p> <p>36: 10.6x ↑</p> <p>37: 8.6 ↓</p> <p>38: 10.7x ↑</p> <p>39: 10.4 ↓</p> <p>40: 9.8 →</p>
	Series 94.5		Series 95.8
	Total 279.0		Total 374.8

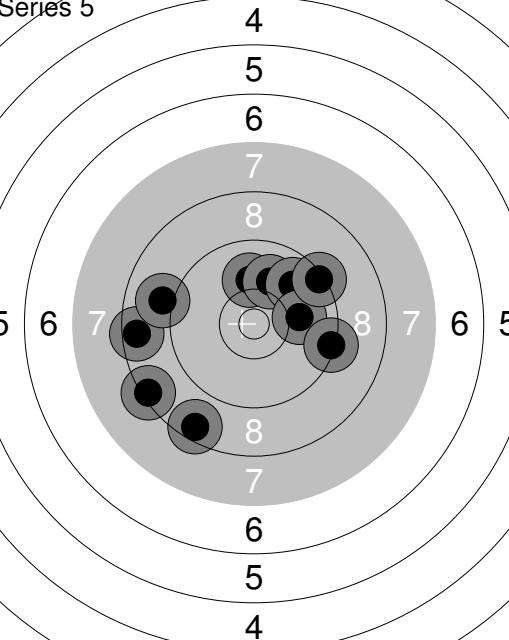
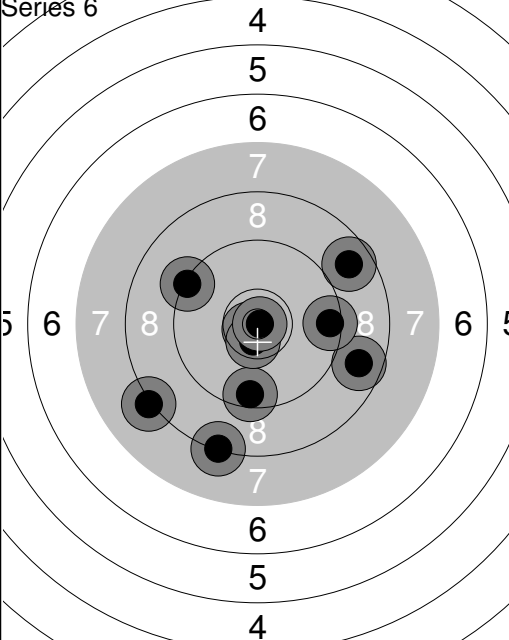
<p>Series 5</p> 	<p>41: 8.5 ←</p> <p>42: 10.0 ↑</p> <p>43: 9.0 ←</p> <p>44: 10.0 ↑</p> <p>45: 9.8 ↗</p> <p>46: 10.0 →</p> <p>47: 8.5 ↓</p> <p>48: 8.4 ←</p> <p>49: 9.3 ↗</p> <p>50: 9.3 →</p>	<p>Series 6</p> 	<p>51: 8.2 ↖</p> <p>52: 8.7 →</p> <p>53: 10.7x ←</p> <p>54: 9.5 ↓</p> <p>55: 8.7 ↗</p> <p>56: 8.3 ↓</p> <p>57: 10.6x ↓</p> <p>58: 9.3 ↖</p> <p>59: 9.5 →</p> <p>60: 10.9x →</p>
	Series 92.8		Series 94.4
	Total 467.6		Total 562.0

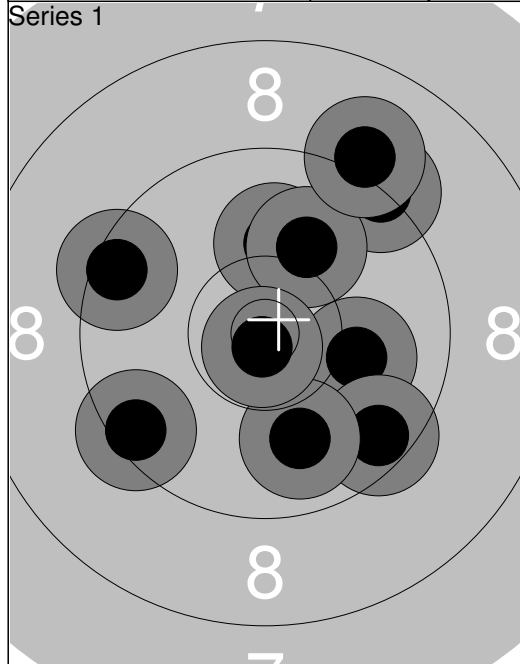

1: 10.1	➔
2: 9.5	↖
3: 9.4	↙
4: 10.1	↑
5: 9.3	↗
6: 10.1	↗
7: 9.5	↘
8: 9.9	↓
9: 10.8x	↓
10: 9.1	↗
Series 97.8	
Total 97.8	

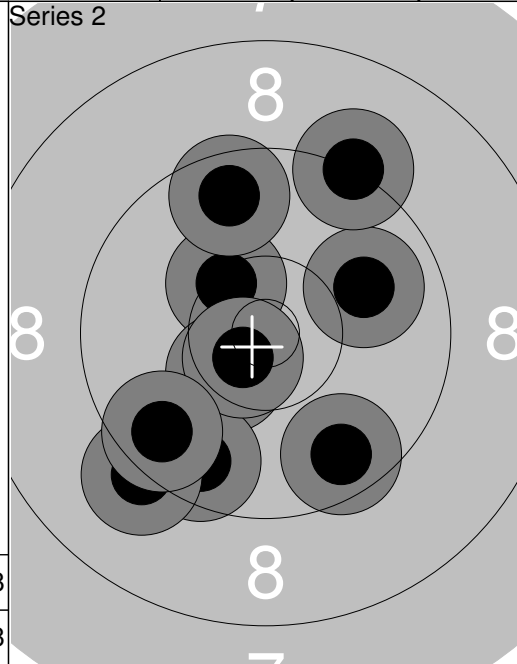

11: 10.4x	↖
12: 10.4x	↙
13: 9.6	↙
14: 9.6	↓
15: 9.2	↙
16: 10.6x	↙
17: 9.6	↙
18: 9.9	➔
19: 9.2	↗
20: 9.6	↑
Series 98.1	
Total 195.9	

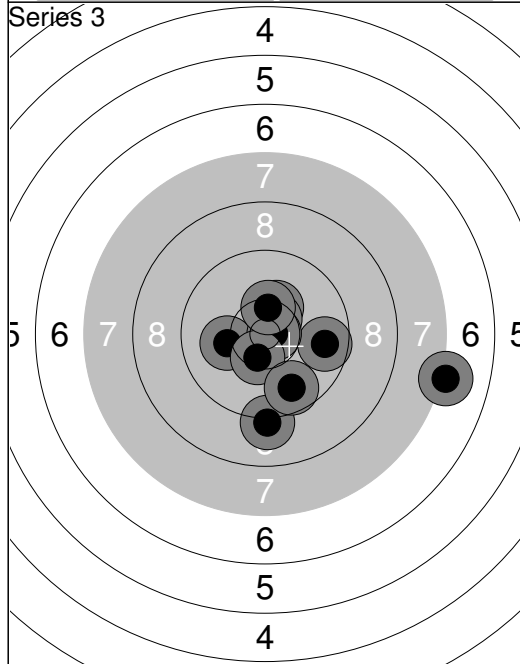

21: 10.1	↖
22: 9.7	➔
23: 7.1	➔
24: 10.4	↗
25: 10.6x	↗
26: 10.8x	➔
27: 9.1	↓
28: 10.4x	↙
29: 10.4x	↑
30: 9.7	↘
Series 98.3	
Total 294.2	

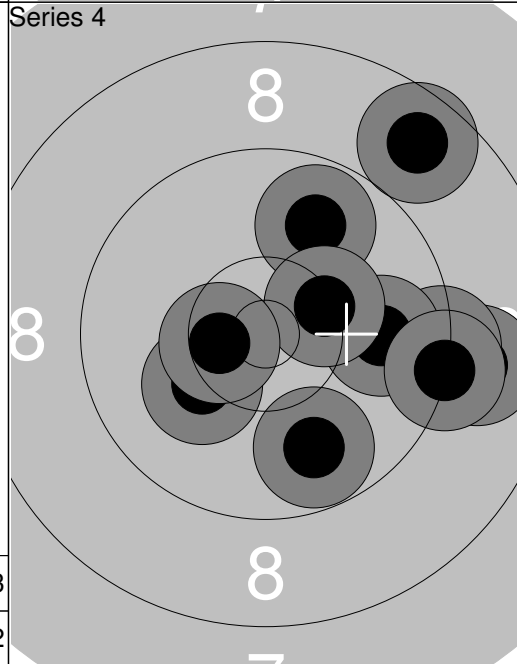

31: 9.8	↗
32: 9.0	➔
33: 9.8	↘
34: 9.3	➔
35: 9.9	➔
36: 9.3	➔
37: 8.7	↗
38: 10.3	➔
39: 10.2	↙
40: 10.5x	↖
Series 96.8	
Total 391.0	

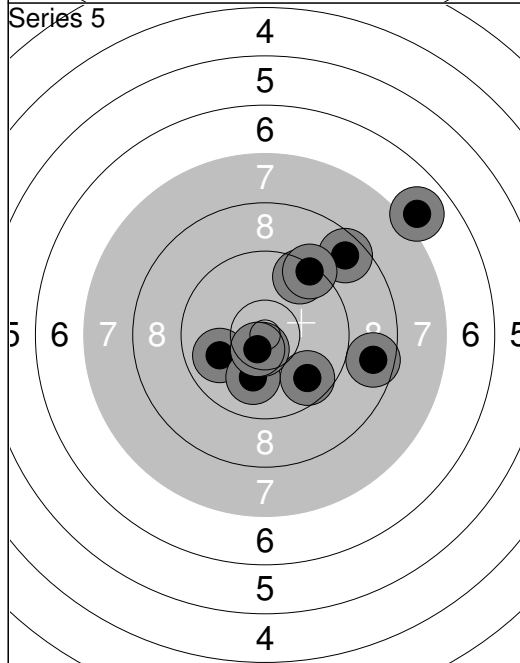

41: 8.7	➔
42: 6.9	↗
43: 8.6	↗
44: 9.9	↖
45: 10.0	↓
46: 9.6	↗
47: 9.7	↘
48: 10.7x	↓
49: 9.4	↗
50: 10.6x	↙
Series 94.1	
Total 485.1	

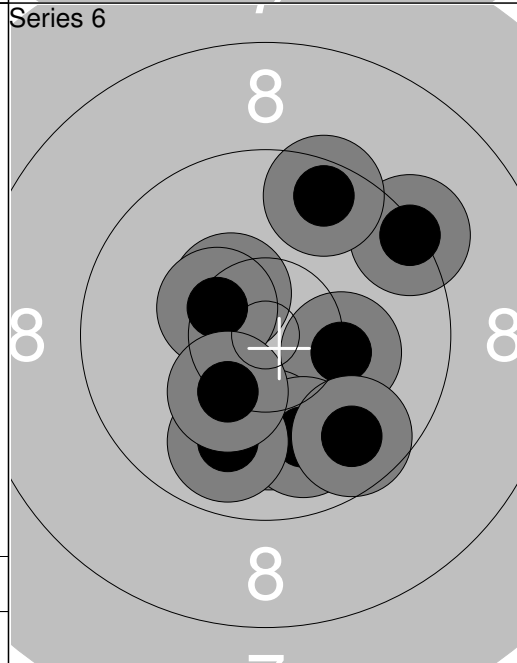

51: 9.3	↗
52: 10.4x	↖
53: 10.2	➔
54: 10.1	↓
55: 9.6	↑
56: 9.9	↓
57: 10.4x	↖
58: 9.9	↓
59: 9.7	↘
60: 10.3	↙
Series 99.8	
Total 584.9	

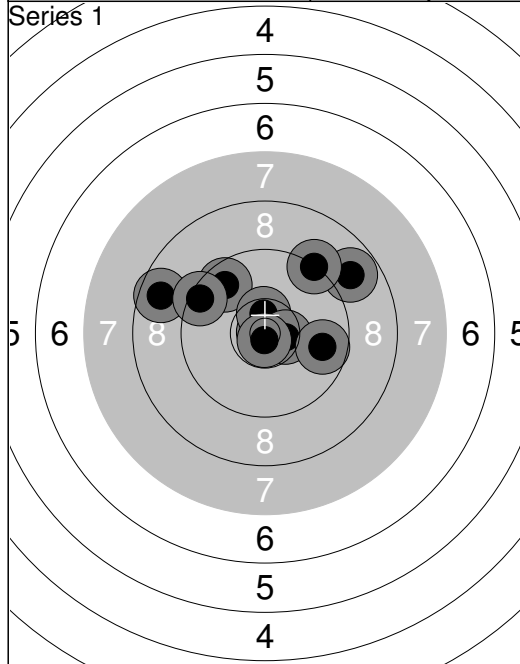

1:	8.7	↙
2:	9.7	↗
3:	10.9x	↖
4:	10.6x	↑
5:	10.5x	→
6:	8.8	↗
7:	9.2	↗
8:	10.8x	↓
9:	9.7	→
10:	9.4	↙
Series	98.3	
Total	98.3	

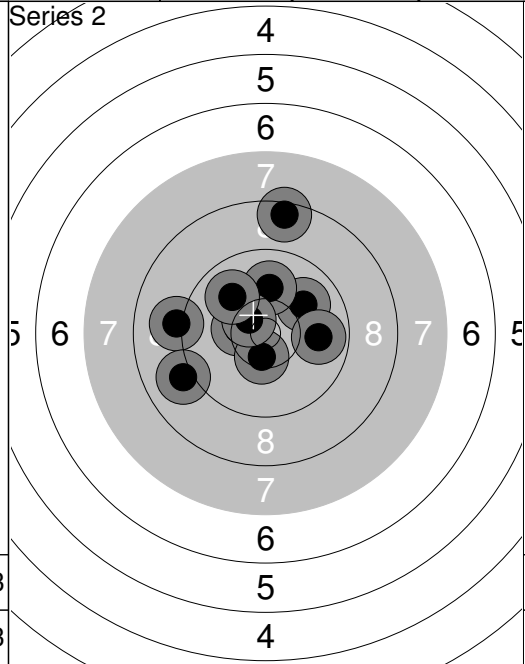

11:	10.0	↗
12:	10.4x	↙
13:	9.1	↙
14:	8.5	↑
15:	10.5x	↓
16:	10.0	↑
17:	9.0	↙
18:	10.5x	↖
19:	9.9	↖
20:	9.9	→
Series	97.8	
Total	196.1	

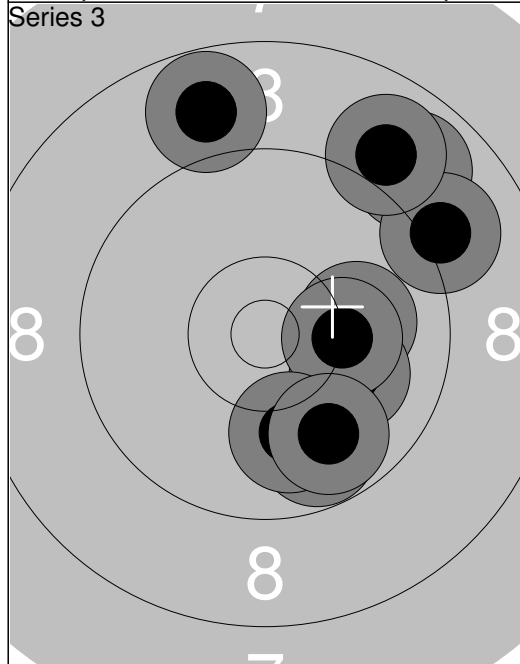

21:	9.8	↓
22:	10.1	→
23:	10.1	→
24:	10.2	→
25:	8.9	↗
26:	10.0	↓
27:	9.1	↗
28:	9.9	↓
29:	8.8	↑
30:	8.9	↗
Series	95.8	
Total	291.9	

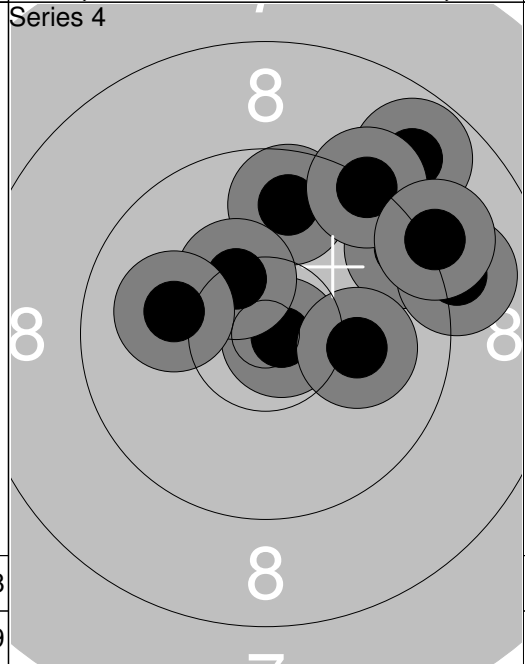

31:	9.4	↗
32:	9.7	↑
33:	8.8	↗
34:	10.8x	→
35:	10.4x	↖
36:	9.1	→
37:	9.3	↗
38:	10.1	↙
39:	9.1	↗
40:	10.1	→
Series	96.8	
Total	388.7	

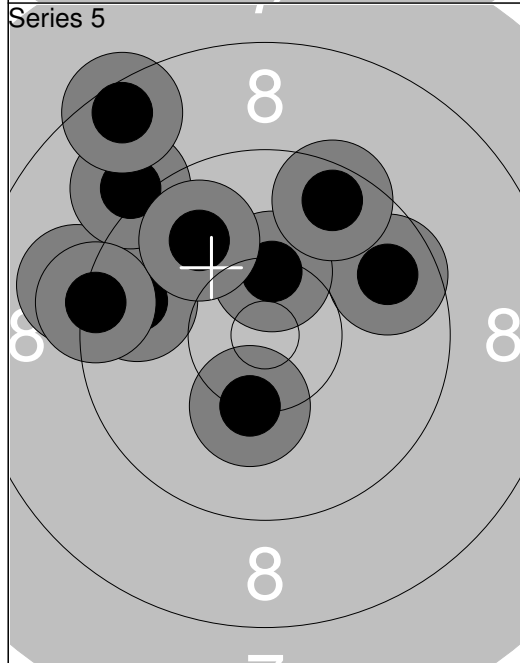

41:	9.1	↙
42:	9.7	↗
43:	10.4x	↑
44:	9.7	↙
45:	9.1	↗
46:	9.6	↗
47:	9.3	↙
48:	10.3	↓
49:	8.5	↗
50:	9.9	↖
Series	95.6	
Total	484.3	

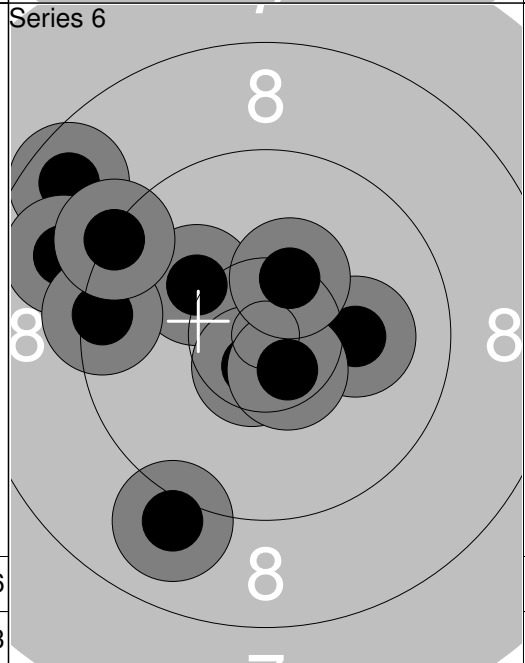

51:	10.1	→
52:	10.2	↖
53:	10.6x	↓
54:	8.6	↖
55:	8.9	↙
56:	10.6x	↓
57:	10.4x	↗
58:	9.0	↓
59:	9.4	↙
60:	9.3	↖
Series	97.1	
Total	581.4	

Relay	Lane	Ville Lehtinen			
Air	P-HA	AP Y			
8.-9.2014	Kevätkilpailut	Kankaanpään Ampumaurheilijat			
Series 1		1: 9.9 ↑	Series 2		11: 9.1 →
		2: 7.9 ←			12: 8.3 ↙
		3: 10.2 ↙			13: 8.3 ↑
		4: 9.7 ↑			14: 8.9 ↖
5: 9.0 ↓	15: 9.3 ↓				
6: 9.4 ↗	16: 7.5 ↑				
7: 10.3 ↑	17: 9.1 →				
8: 8.6 ↗	18: 9.5 ↓				
9: 9.1 ↑	19: 10.3 ←				
10: 8.6 ←	20: 9.2 ↗				
Series	92.7	Series	89.5		
Total	92.7	Total	182.2		
Series 3		21: 9.9 ↗	Series 4		31: 10.0 →
		22: 9.6 ↘			32: 8.3 ↑
		23: 8.9 ↗			33: 10.2 →
		24: 9.8 ↓			34: 10.0 ↖
25: 8.3 →	35: 8.1 ←				
26: 9.5 ↙	36: 9.6 ↗				
27: 8.8 ↓	37: 10.3 ↓				
28: 8.5 ↙	38: 8.1 ↓				
29: 7.1 ↗	39: 10.2 ↖				
30: 10.6x ↑	40: 8.7 ↓				
Series	91.0	Series	93.5		
Total	273.2	Total	366.7		
Series 5		41: 8.2 ↗	Series 6		51: 10.5x ←
		42: 9.9 ↘			52: 10.5x ←
		43: 10.3 ↙			53: 10.1 ←
		44: 9.6 ↓			54: 7.0 ↙
45: 8.3 ↗	55: 9.4 ↓				
46: 9.8 ←	56: 9.8 ↖				
47: 8.9 ↓	57: 10.6x ↓				
48: 9.1 ←	58: 10.2 ↑				
49: 10.1 ↓	59: 8.6 ↑				
50: 7.4 ↑	60: 8.8 ↖				
Series	91.6	Series	95.5		
Total	458.3	Total	553.8		

Relay	Lane	Antti Tervo	
Air	SA	AP Y	
8.-9.2014	Kevätkilpailut	Kankaanpään Ampumaurheilijat	
Series 1		1: 9.4 →	Series 2
		2: 9.0 ↗	11: 10.7x ↙
		3: 9.2 ↗	12: 9.8 →
		4: 10.1 ↑	13: 9.8 ↖
		5: 9.5 ←	14: 9.7 ↓
		6: 10.2 ←	15: 9.6 ↑
		7: 10.2 ↙	16: 10.3 ←
		8: 10.2 ↙	17: 9.7 →
		9: 10.3 ←	18: 9.5 ↗
		10: 9.9 ↓	19: 9.6 ↖
		20: 10.3 ←	
	Series	98.0	Series
	Total	98.0	Total
			197.0
Series 3		21: 10.5x ↓	Series 4
		22: 10.1 →	31: 10.2 ↖
		23: 8.9 ←	32: 9.8 →
		24: 9.7 ↗	33: 10.5x →
		25: 10.1 ↙	34: 8.8 ↖
		26: 9.8 ←	35: 10.0 →
		27: 9.9 ←	36: 8.9 ↖
		28: 9.3 ↙	37: 9.3 ↓
		29: 10.9x ↙	38: 10.9x ↑
		30: 10.0 ↖	39: 10.5x ↓
		40: 10.3 ↖	
	Series	99.2	Series
	Total	296.2	Total
			395.4
Series 5		41: 10.1 ↑	Series 6
		42: 10.0 ↖	51: 10.8x ↙
		43: 10.1 →	52: 10.3 →
		44: 9.3 ←	53: 9.6 ←
		45: 9.7 ←	54: 10.4x →
		46: 10.6x ↑	55: 10.1 ←
		47: 10.3 ↓	56: 9.8 ↗
		48: 9.9 ↖	57: 10.0 ←
		49: 9.8 ↑	58: 9.7 ↖
		50: 10.1 ←	59: 9.8 ↖
		60: 8.9 ↓	
	Series	99.9	Series
	Total	495.3	Total
			594.7

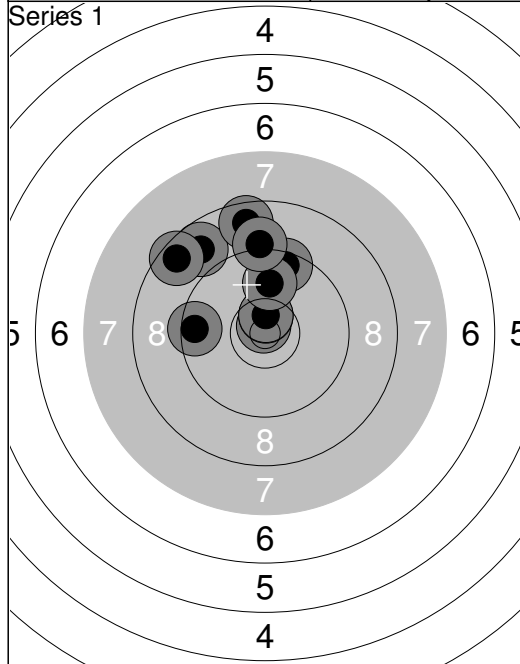

1:	8.8	↖
2:	9.5	←
3:	10.8x	↗
4:	10.6x	↑
5:	10.6x	↑
6:	9.5	↑
7:	8.6	↖
8:	9.9	↑
9:	8.7	↑
10:	9.1	↑
Series	96.1	
Total	96.1	

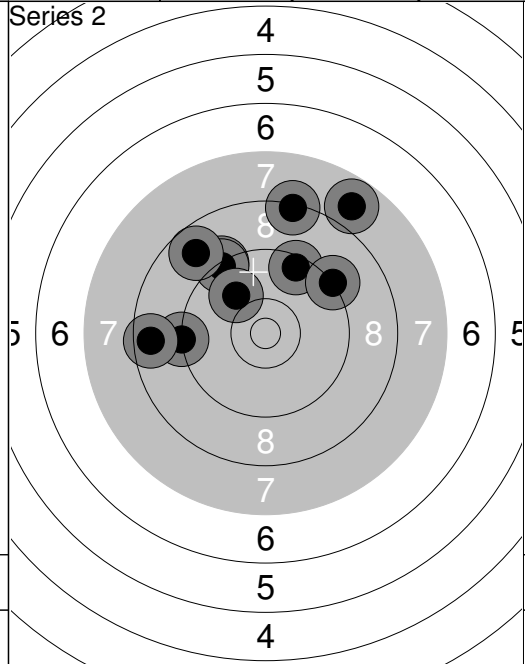

11:	9.2	↖
12:	9.3	↖
13:	7.8	↗
14:	8.8	↖
15:	9.2	←
16:	10.0	↖
17:	8.3	↑
18:	9.5	↗
19:	9.2	↗
20:	8.6	←
Series	89.9	
Total	186.0	

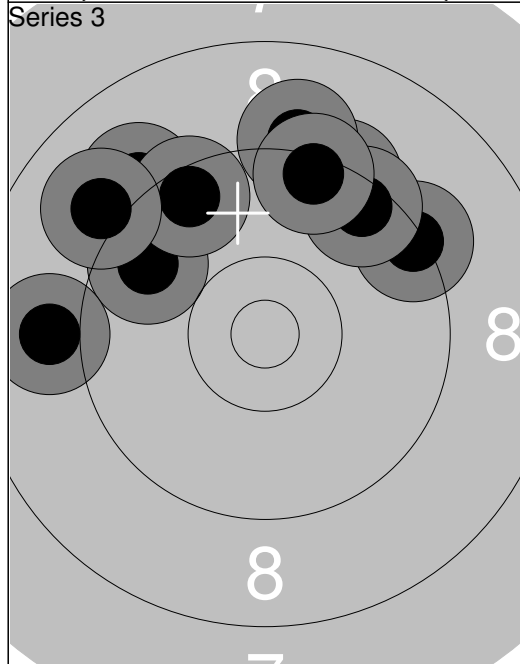

21:	9.3	↗
22:	9.1	↖
23:	9.3	↗
24:	9.7	↖
25:	8.9	←
26:	9.5	↗
27:	9.0	↖
28:	9.1	↑
29:	9.5	↗
30:	9.4	↑
Series	92.8	
Total	278.8	

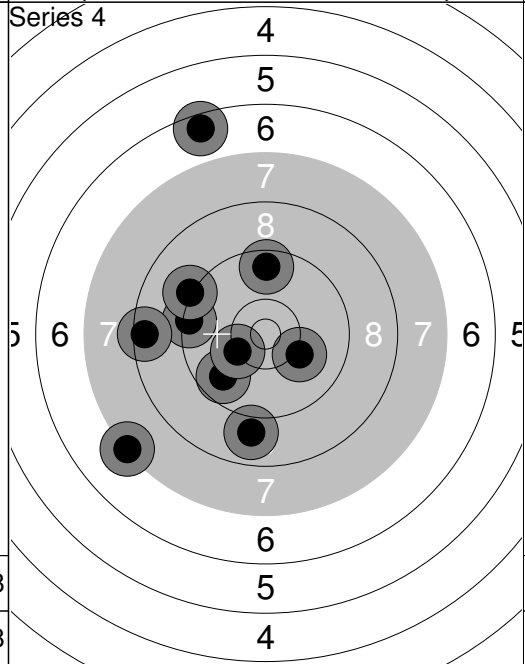

31:	10.1	↘
32:	8.9	↓
33:	6.5	↑
34:	9.7	↖
35:	10.3	↖
36:	9.4	←
37:	9.2	↖
38:	9.6	↑
39:	8.5	←
40:	7.3	↖
Series	89.5	
Total	368.3	

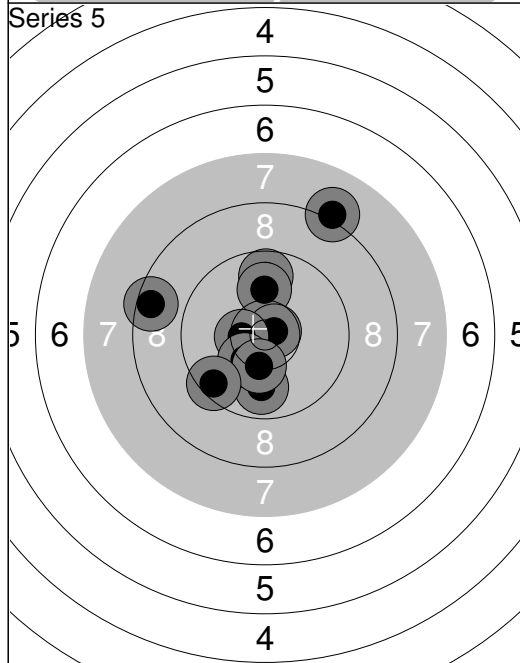

41:	9.9	↓
42:	9.7	↑
43:	10.0	↑
44:	8.1	↗
45:	10.7x	↗
46:	10.5x	←
47:	8.5	←
48:	10.3	↖
49:	10.3	↓
50:	9.5	↖
Series	97.5	
Total	465.8	

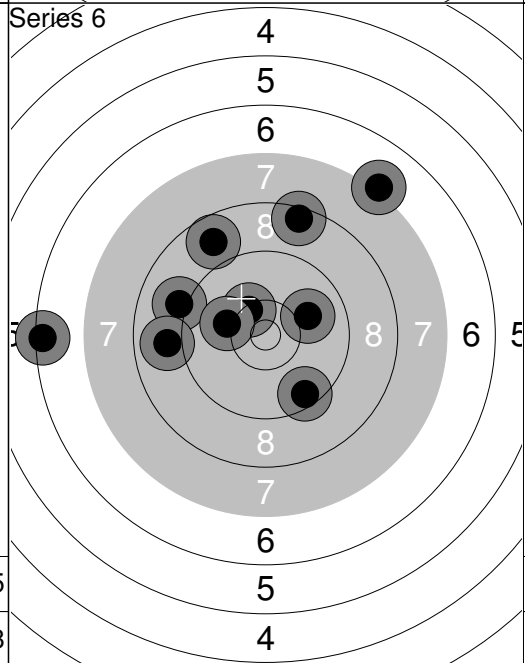

51:	6.4	←
52:	9.1	↖
53:	9.5	↘
54:	7.1	↗
55:	10.0	↗
56:	10.3	↖
57:	10.1	←
58:	8.9	←
59:	8.5	↑
60:	8.8	↖
Series	88.7	
Total	554.5	

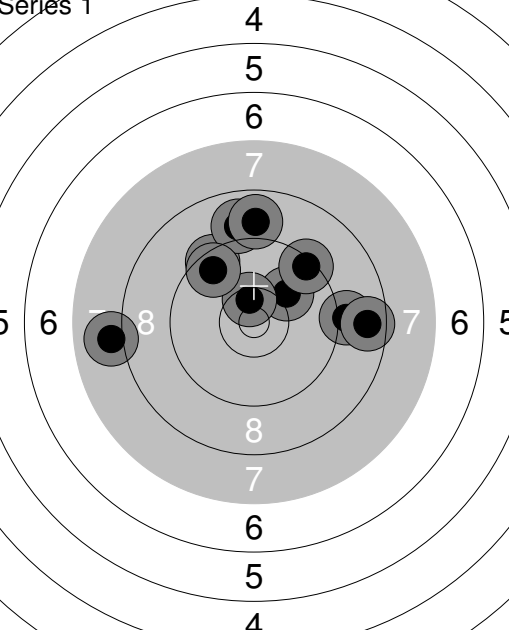
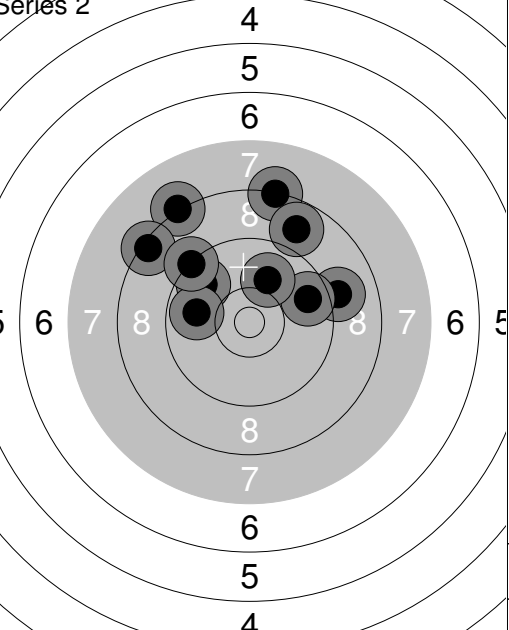
<p>Series 1</p> 	<p>1: 8.0 ←</p> <p>2: 9.1 →</p> <p>3: 9.5 ↖</p> <p>4: 10.1 ↗</p> <p>5: 10.5x ↑</p> <p>6: 9.0 ↑</p> <p>7: 9.4 ↗</p> <p>8: 8.6 →</p> <p>9: 8.9 ↑</p> <p>10: 9.6 ↖</p> <hr/> <p>Series 92.7</p> <hr/> <p>Total 92.7</p>	<p>Series 2</p> 	<p>11: 9.7 ↖</p> <p>12: 8.2 ↖</p> <p>13: 8.3 ↑</p> <p>14: 9.0 →</p> <p>15: 8.8 ↗</p> <p>16: 8.4 ↖</p> <p>17: 9.7 ↗</p> <p>18: 10.0 ↗</p> <p>19: 9.8 ←</p> <p>20: 9.3 ↖</p> <hr/> <p>Series 91.2</p> <hr/> <p>Total 183.9</p>
--	--	--	--

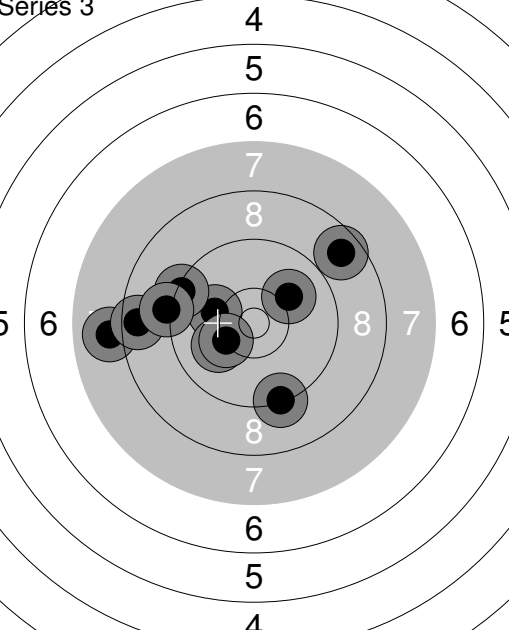
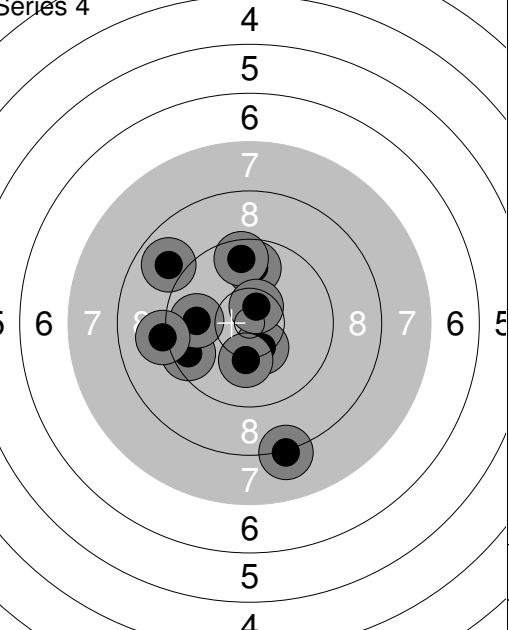
<p>Series 3</p> 	<p>21: 8.0 ←</p> <p>22: 8.6 ←</p> <p>23: 10.1 ↗</p> <p>24: 9.3 ↓</p> <p>25: 8.7 ↗</p> <p>26: 10.1 ←</p> <p>27: 9.3 ←</p> <p>28: 9.1 ←</p> <p>29: 10.1 ←</p> <p>30: 10.3 ←</p> <hr/> <p>Series 93.6</p> <hr/> <p>Total 277.5</p>	<p>Series 4</p> 	<p>31: 9.6 ↖</p> <p>32: 9.8 ↑</p> <p>33: 9.9 ←</p> <p>34: 9.6 ↑</p> <p>35: 10.4x ↓</p> <p>36: 8.9 ↖</p> <p>37: 9.1 ←</p> <p>38: 8.2 ↓</p> <p>39: 10.6x ↑</p> <p>40: 10.2 ↓</p> <hr/> <p>Series 96.3</p> <hr/> <p>Total 373.8</p>
---	---	---	--

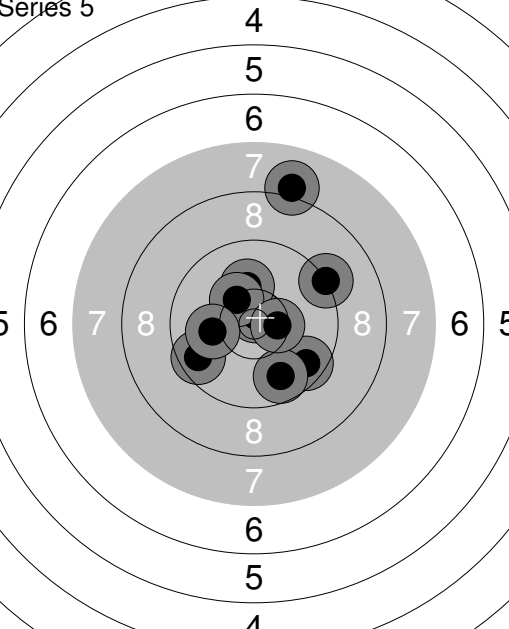
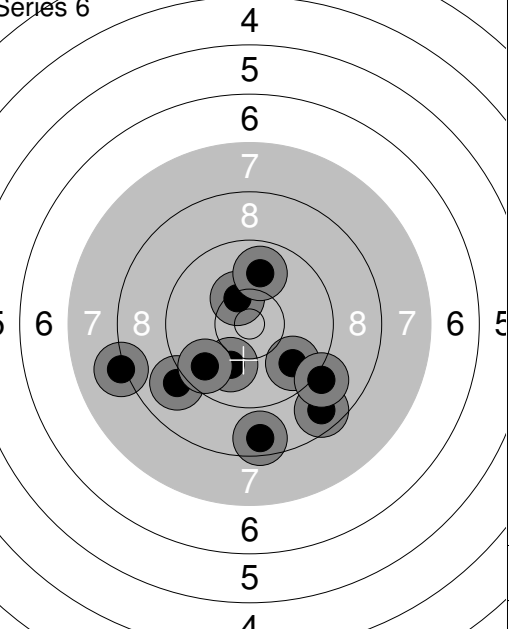
<p>Series 5</p> 	<p>41: 9.6 ↖</p> <p>42: 9.6 ↘</p> <p>43: 10.8x ↑</p> <p>44: 10.2 ↑</p> <p>45: 8.1 ↑</p> <p>46: 9.2 ↗</p> <p>47: 10.3 ↖</p> <p>48: 9.8 ↓</p> <p>49: 10.1 ←</p> <p>50: 10.5x →</p> <hr/> <p>Series 98.2</p> <hr/> <p>Total 472.0</p>	<p>Series 6</p> 	<p>51: 9.0 ↖</p> <p>52: 10.0 ↓</p> <p>53: 9.7 ↖</p> <p>54: 8.2 ←</p> <p>55: 8.6 ↓</p> <p>56: 10.4x ↖</p> <p>57: 8.7 ↘</p> <p>58: 9.9 ↑</p> <p>59: 9.8 ↘</p> <p>60: 9.1 ↘</p> <hr/> <p>Series 93.4</p> <hr/> <p>Total 565.4</p>
--	--	--	--

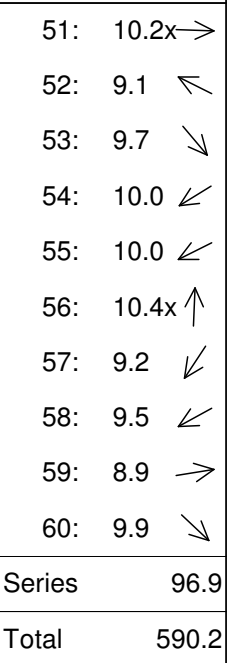
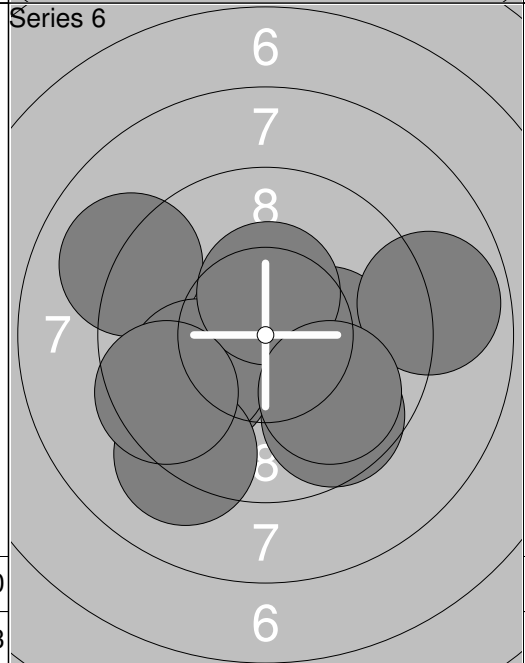
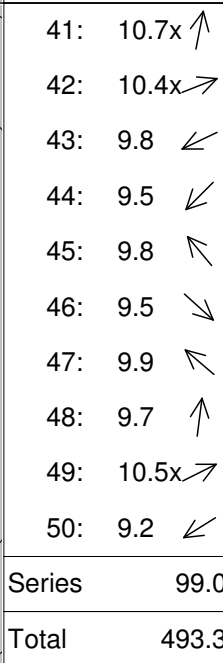
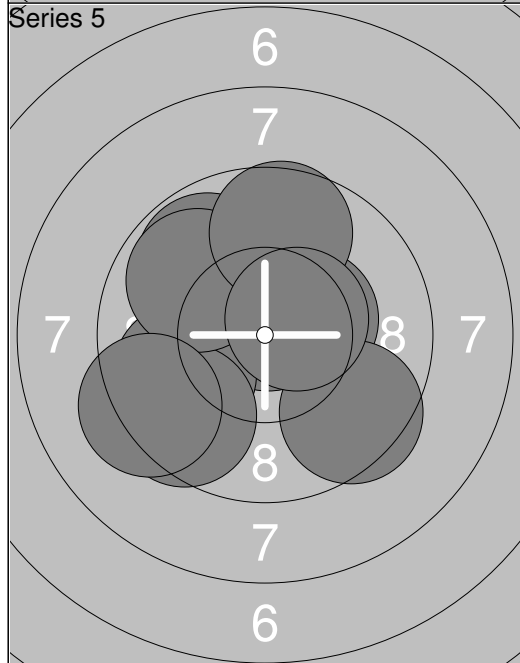
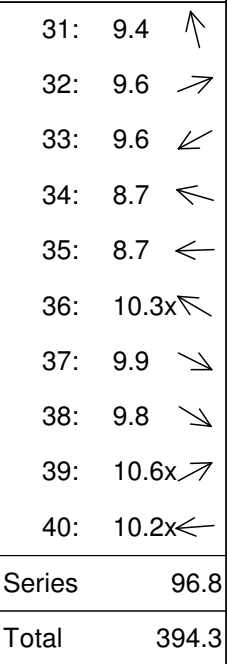
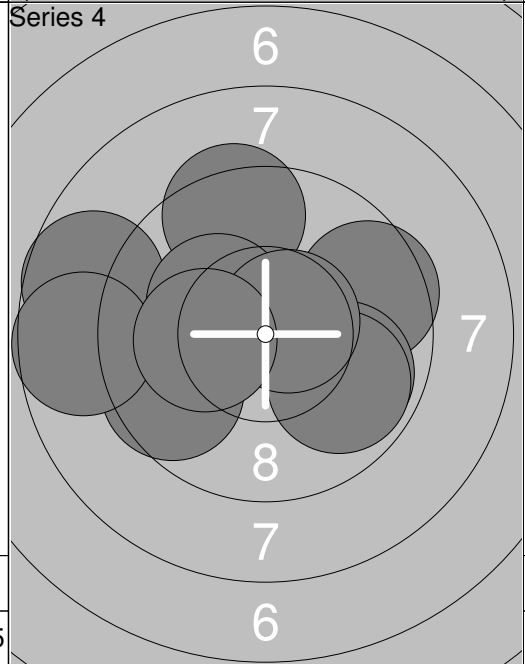
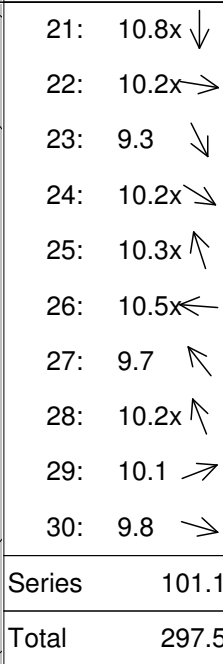
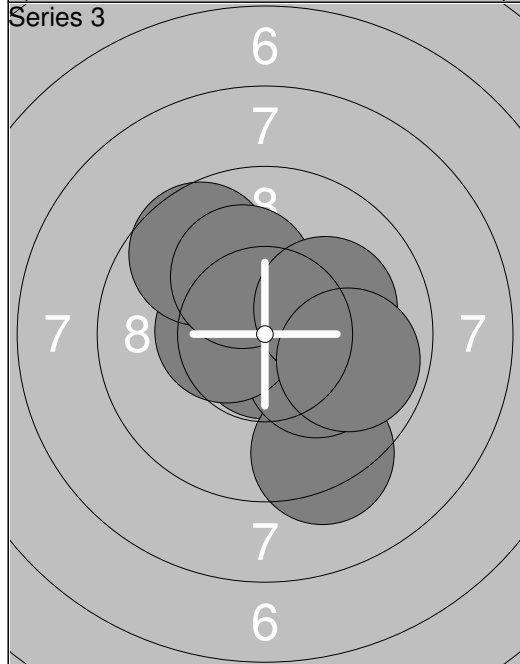
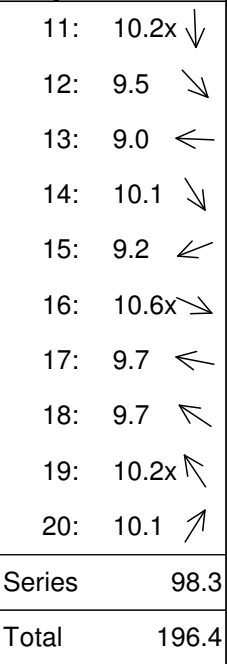
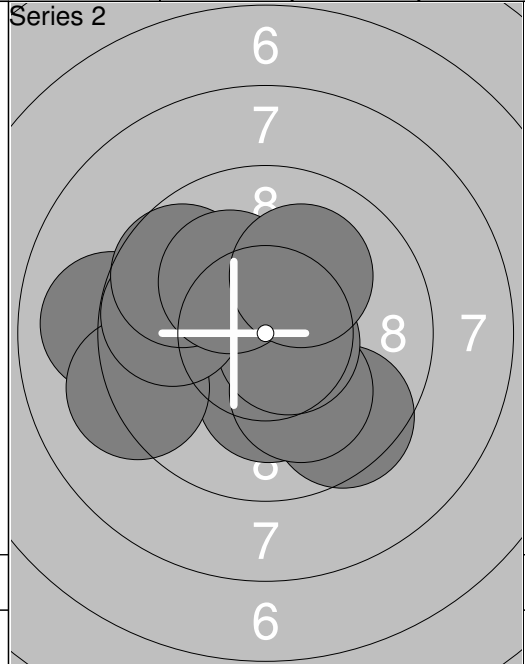
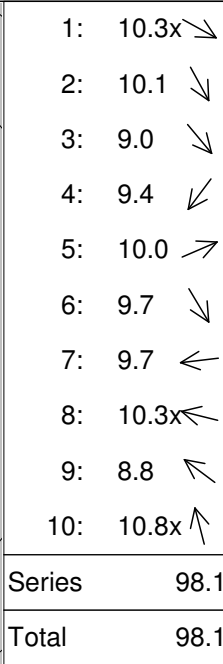
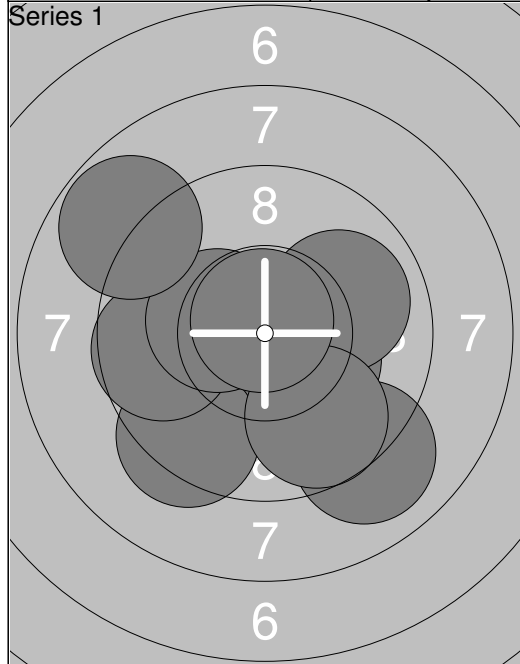

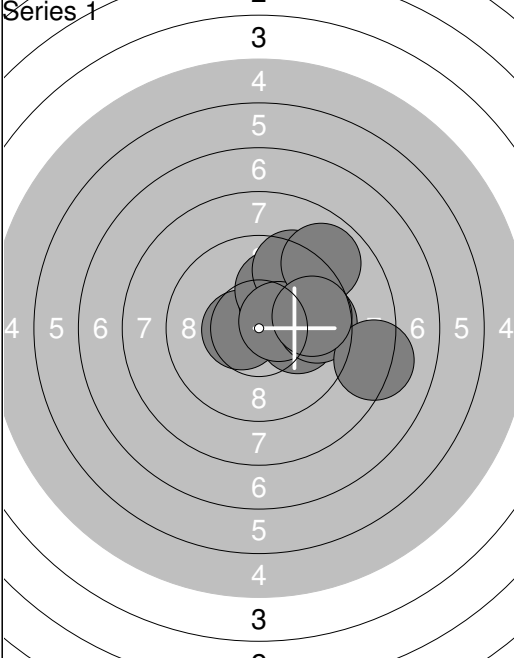
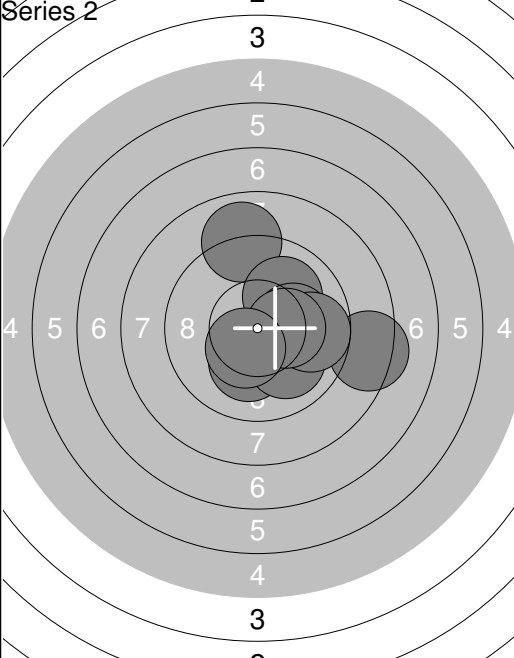
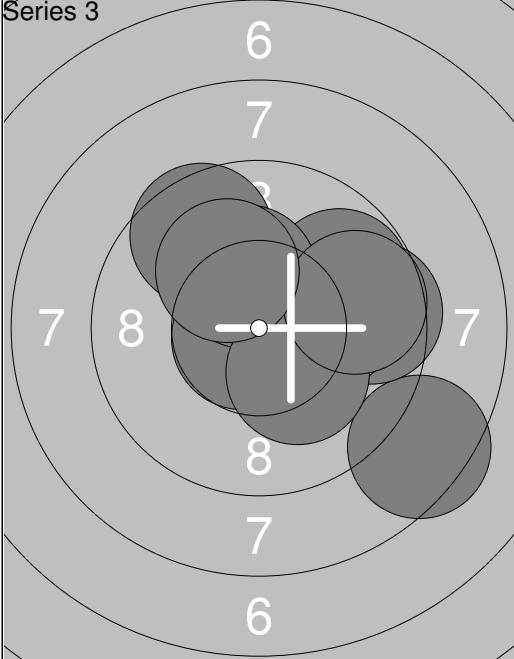
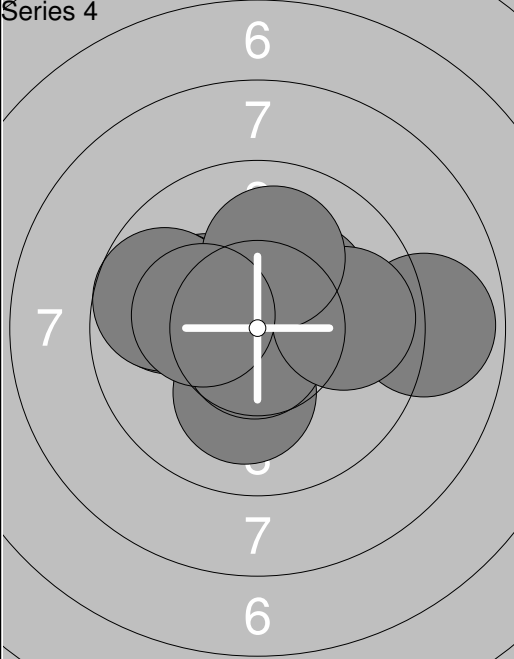
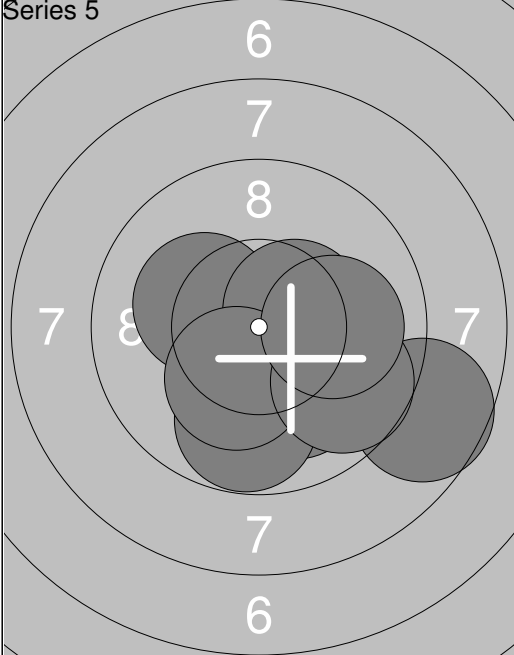
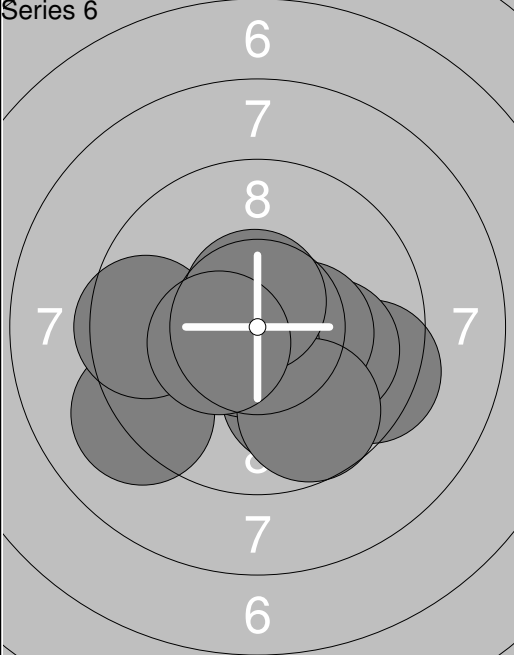
Relay	Lane	Mika Ketola			
Air	KA	AR Y20			
8.-9.2014	Kevätkilpailut	Kankaanpään Ampumaurheilijat			
Series 1		1: 10.1 → 2: 10.5x ← 3: 10.2x ↗ 4: 10.0 ↗ 5: 9.4 ↗ 6: 10.5x → 7: 9.6 → 8: 8.2 → 9: 8.9 ↗ 10: 9.7 →	Series 2		11: 10.4x ↓ 12: 9.0 ↑ 13: 10.2x ↓ 14: 10.0 ↗ 15: 8.4 → 16: 10.0 ↓ 17: 10.1 → 18: 9.8 → 19: 10.3x → 20: 10.4x ↓
	Series 97.1		Series 98.6		
	Total 97.1		Total 195.7		
Series 3		21: 8.5 ↓ 22: 9.6 ↗ 23: 9.5 → 24: 10.7x ← 25: 9.8 ↗ 26: 10.1 → 27: 10.3x ↑ 28: 10.2x ↓ 29: 9.7 → 30: 10.1 ↗	Series 4		31: 10.3x ↗ 32: 10.2x ↓ 33: 8.9 → 34: 10.3x ← 35: 10.7x ↓ 36: 9.9 → 37: 9.8 ← 38: 9.7 ← 39: 10.1 ↑ 40: 10.3x ←
	Series 98.5		Series 100.2		
	Total 294.2		Total 394.4		
Series 5		41: 10.2x ← 42: 10.2x ↓ 43: 10.4x ↓ 44: 10.5x → 45: 10.1 ↓ 46: 9.8 ↓ 47: 10.3x ↓ 48: 8.7 → 49: 9.7 ↓ 50: 10.0 →	Series 6		51: 9.5 → 52: 9.2 ← 53: 9.5 ← 54: 10.0 → 55: 10.0 ↓ 56: 10.4x → 57: 10.7x ↓ 58: 9.7 ↓ 59: 10.6x ↑ 60: 10.4x ←
	Series 99.9		Series 100.0		
	Total 494.3		Total 594.3		

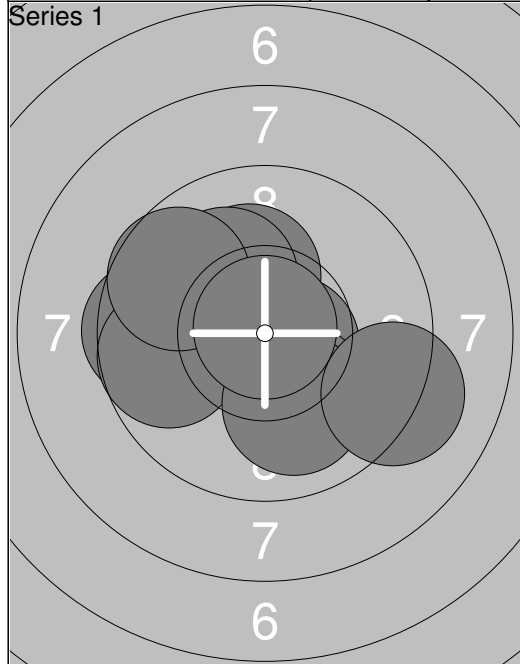

1: 9.5 ←
2: 10.2x ↑
3: 10.6x ↘
4: 10.1 ↗
5: 9.7 ←
6: 10.1 ↘
7: 10.0 ↘
8: 9.2 ↘
9: 9.7 ↖
10: 10.9x ↑
Series 100.0
Total 100.0

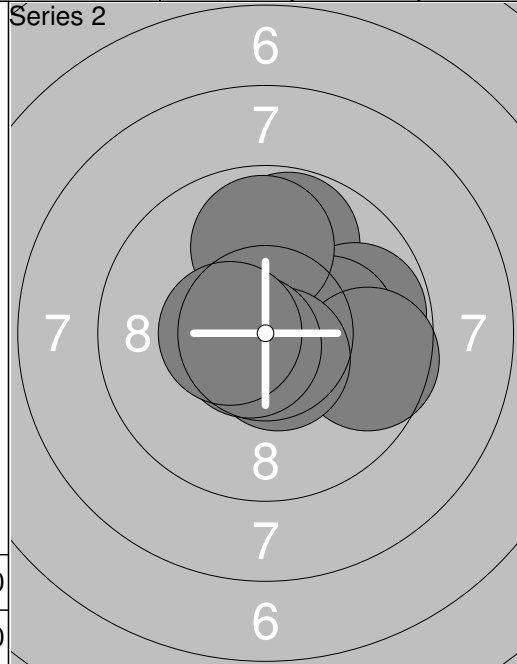

11: 10.4x ↑
12: 9.8 ↑
13: 9.8 →
14: 10.5x →
15: 10.2x →
16: 9.6 →
17: 9.9 ↑
18: 10.6x ↘
19: 10.7x ↙
20: 10.5x ←
Series 102.0
Total 202.0

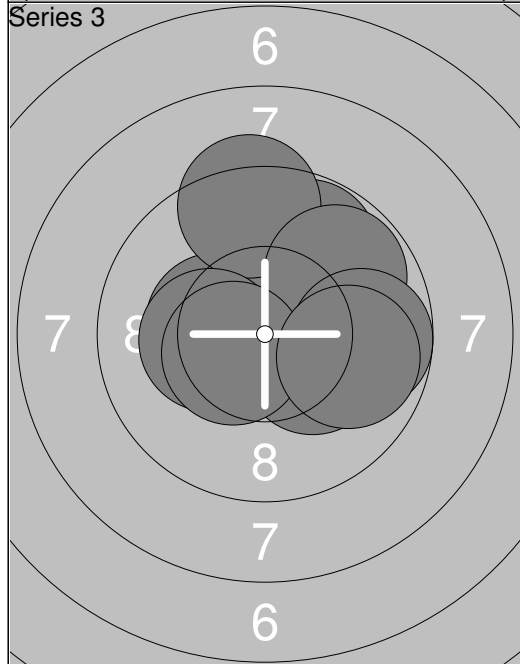

21: 10.7x ↗
22: 10.4x ←
23: 10.2x ↘
24: 9.8 ↑
25: 9.3 ↑
26: 9.8 ↗
27: 10.3x ←
28: 10.5x ↙
29: 9.8 →
30: 9.9 →
Series 100.7
Total 302.7

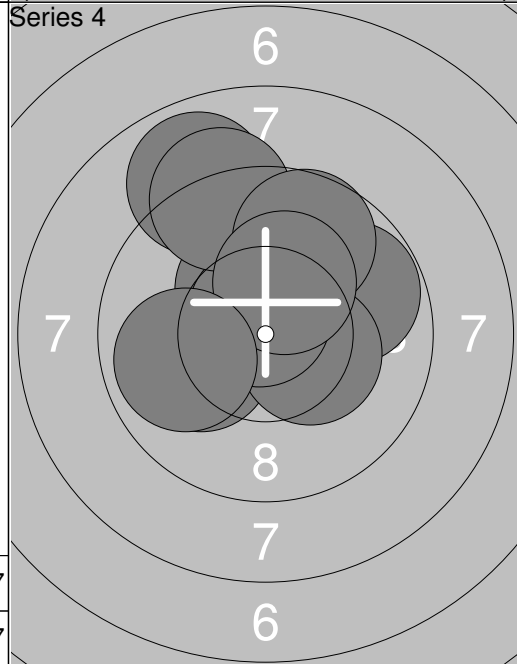

31: 9.8 ↗
32: 10.1 ←
33: 8.9 ↖
34: 10.4x ↖
35: 10.4x ↘
36: 10.7x ↖
37: 9.2 ↖
38: 9.7 ↑
39: 10.2x ↑
40: 9.9 ←
Series 99.3
Total 402.0

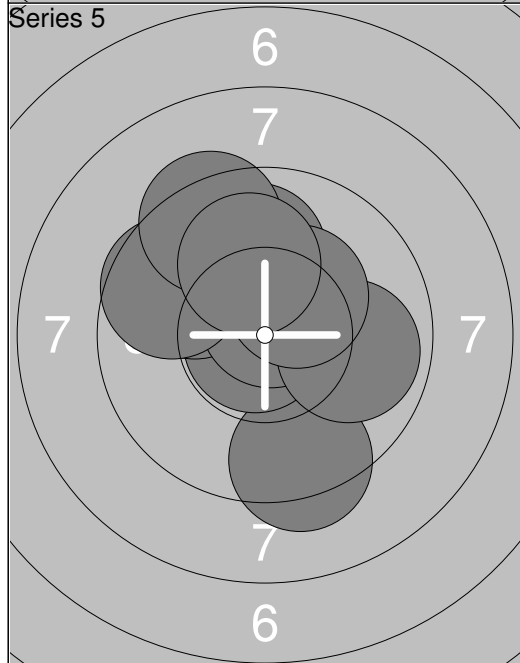

41: 9.3 ↘
42: 10.8x ↙
43: 9.9 ↖
44: 10.0 ↑
45: 10.7x ↑
46: 9.6 ↖
47: 9.4 ↗
48: 9.9 →
49: 10.3x ↗
50: 10.0 ↑
Series 99.9
Total 501.9

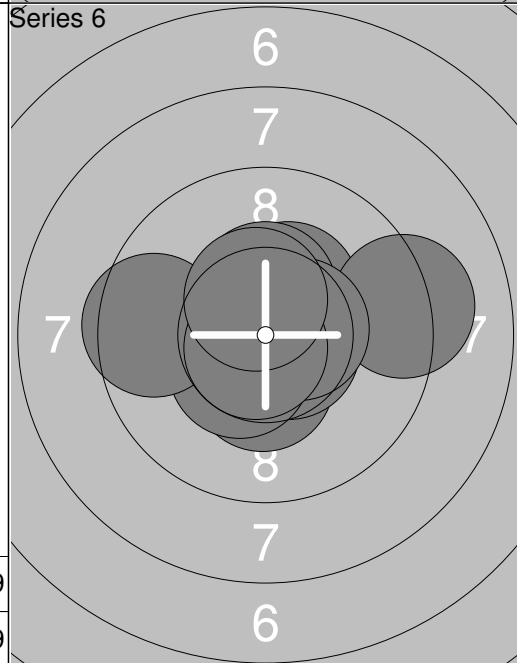

51: 10.4x ↘
52: 10.4x ↗
53: 10.4x ↑
54: 10.6x ↘
55: 9.2 →
56: 10.4x ↙
57: 9.6 ←
58: 10.5x →
59: 10.7x ↙
60: 10.5x ↖
Series 102.7
Total 604.6

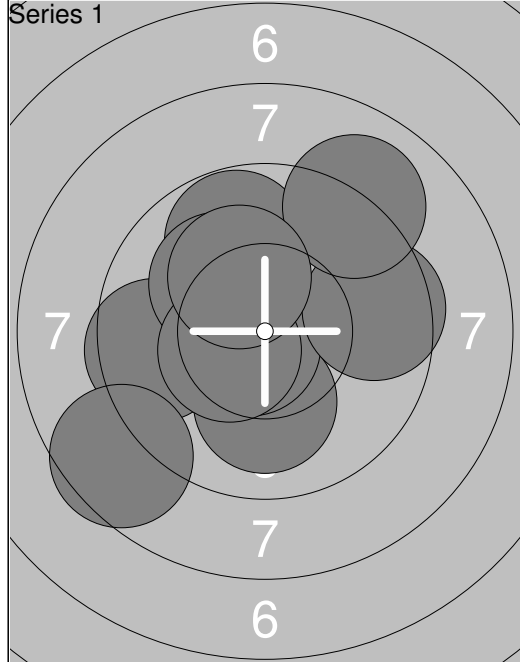

1:	9.6	←
2:	10.1	↓
3:	8.5	↙
4:	9.8	↑
5:	10.7x	↙
6:	9.6	→
7:	9.0	↗
8:	10.1	↖
9:	10.5x	↙
10:	10.2x	↗
Series	98.1	
Total	98.1	

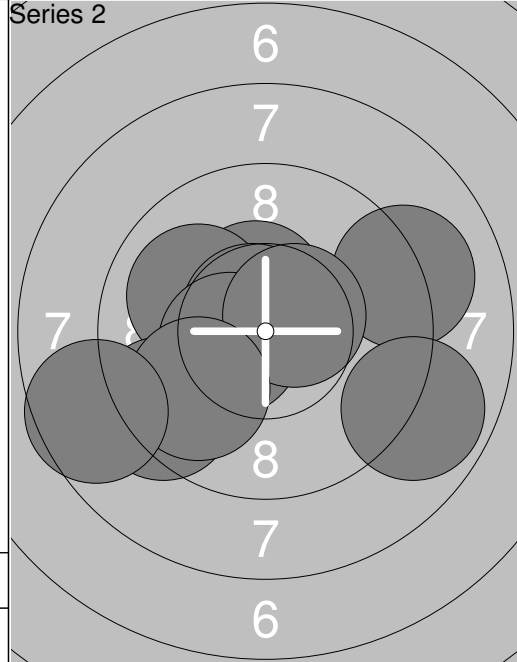

11:	10.5x	↗
12:	10.0	↖
13:	10.7x	↖
14:	9.4	↙
15:	9.1	→
16:	10.5x	↙
17:	8.9	→
18:	10.5x	↗
19:	9.8	↙
20:	8.6	↙
Series	98.0	
Total	196.1	

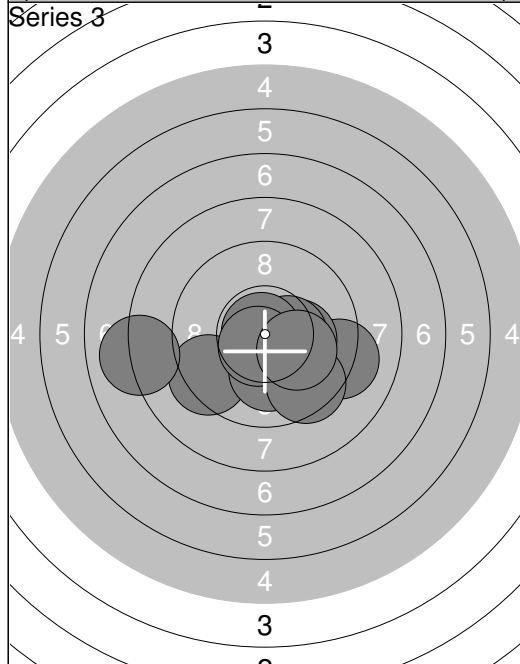

21:	9.2	→
22:	9.4	↙
23:	10.1	↓
24:	10.2x	→
25:	10.4x	→
26:	10.9x	↖
27:	10.6x	↙
28:	9.5	↘
29:	10.1	→
30:	8.1	←
Series	98.5	
Total	294.6	

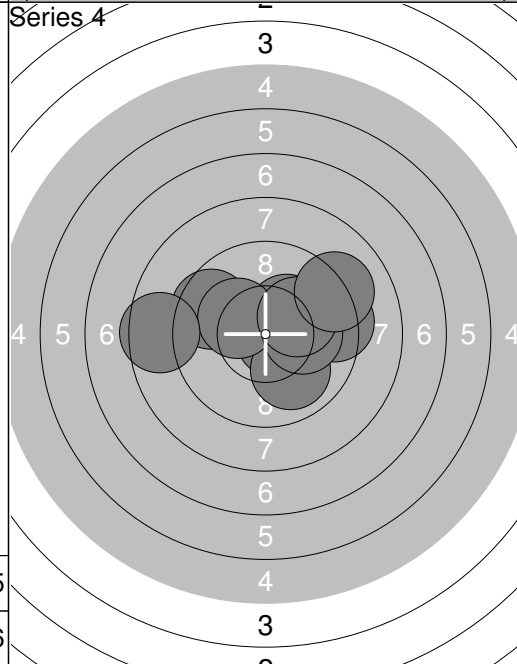

31:	10.3x	↗
32:	9.6	↖
33:	10.7x	→
34:	10.0	↘
35:	10.2x	↖
36:	8.5	←
37:	9.3	→
38:	10.1	→
39:	10.1	↗
40:	9.1	↗
Series	97.9	
Total	392.5	

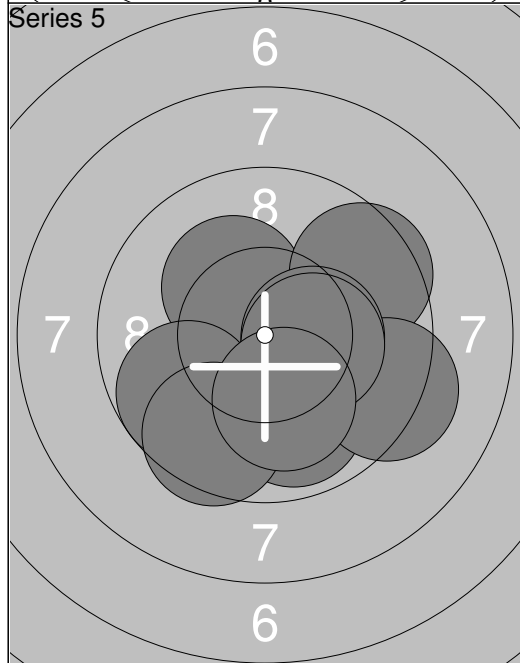

41:	9.8	↙
42:	9.9	↘
43:	10.2x	↖
44:	9.8	↙
45:	9.5	↘
46:	9.5	↗
47:	9.3	→
48:	10.3x	→
49:	10.3x	→
50:	10.1	↘
Series	98.7	
Total	491.2	

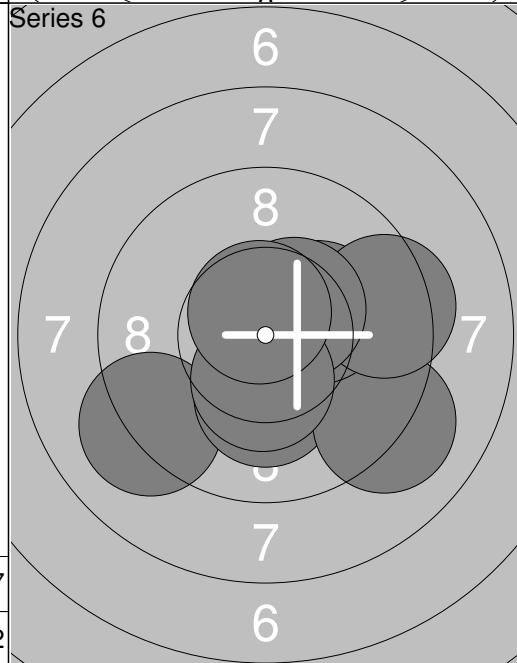

51:	10.0	→
52:	9.1	↙
53:	10.2x	↓
54:	10.0	→
55:	9.1	↘
56:	10.3x	↗
57:	9.4	→
58:	10.5x	↗
59:	10.4x	↓
60:	10.7x	↖
Series	99.7	
Total	590.9	

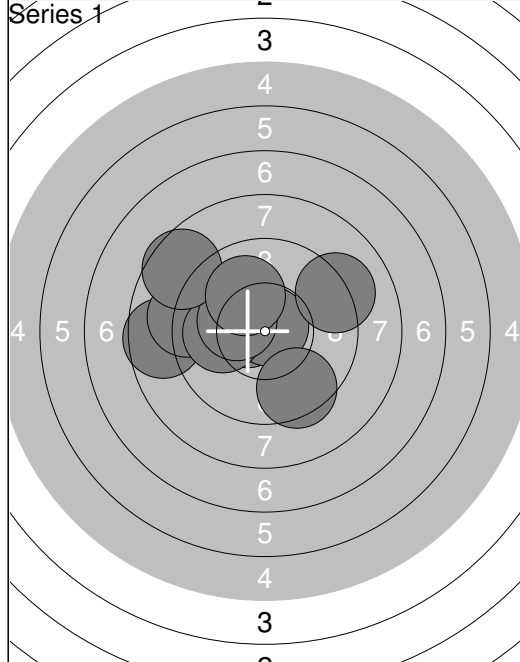

1: 10.5x	←
2: 8.6	←
3: 9.2	←
4: 10.8x	↗
5: 10.0	←
6: 10.3x	←
7: 8.6	↗
8: 9.5	↘
9: 10.0	↗
10: 9.1	↗
Series	96.6
Total	96.6

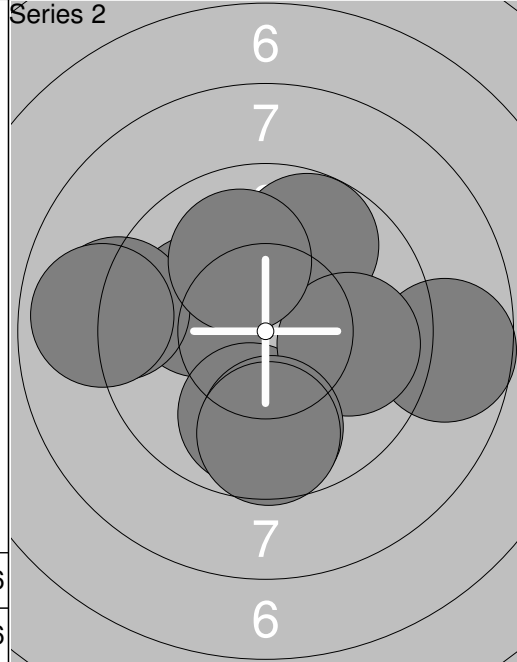

11: 10.1	←
12: 9.1	←
13: 8.9	←
14: 9.8	↗
15: 8.7	→
16: 9.9	↓
17: 9.9	→
18: 9.8	↓
19: 9.7	↓
20: 10.0	↗
Series	95.9
Total	192.5

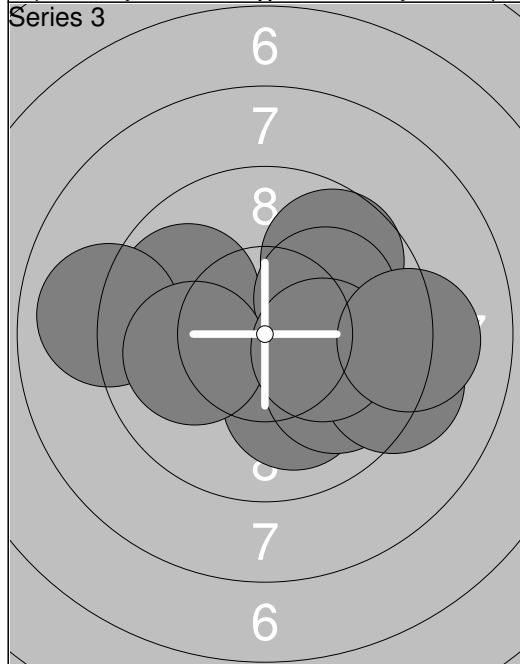

21: 10.1	↓
22: 9.7	↗
23: 9.9	←
24: 9.0	←
25: 10.1	↗
26: 9.9	↘
27: 10.1	←
28: 9.3	→
29: 10.2x	→
30: 9.1	→
Series	97.4
Total	289.9

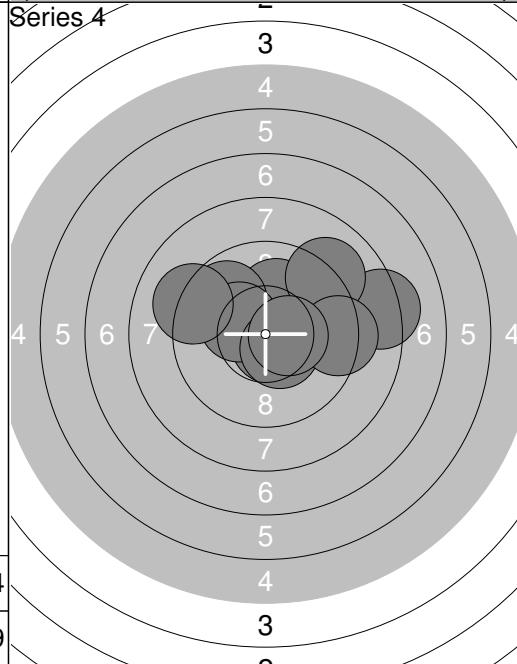

31: 10.1	↗
32: 8.3	→
33: 9.8	←
34: 10.7x	↘
35: 10.3x	←
36: 9.1	↗
37: 10.5x	↘
38: 9.3	→
39: 9.2	←
40: 10.4x	→
Series	97.7
Total	387.6

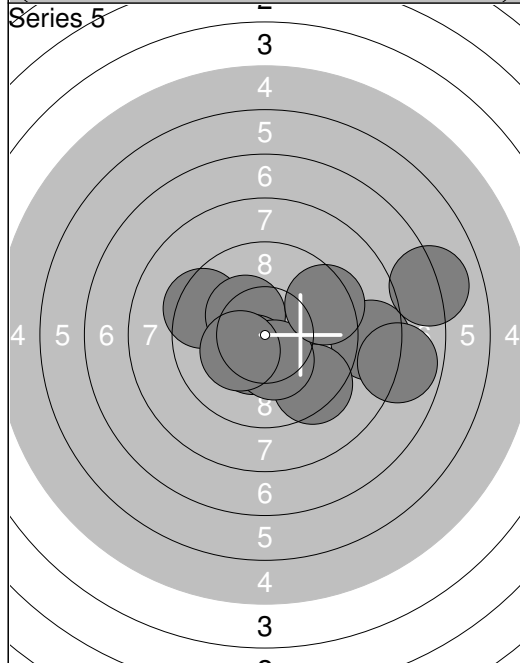

41: 8.6	→
42: 7.1	→
43: 9.4	←
44: 10.3x	↗
45: 10.4x	↘
46: 9.4	↘
47: 10.4x	↘
48: 9.5	↗
49: 10.3x	←
50: 7.9	→
Series	93.3
Total	480.9

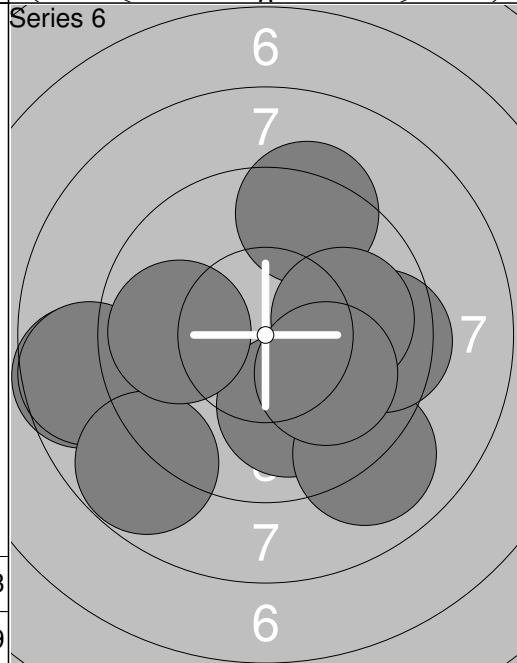

51: 9.3	↗
52: 10.0	↓
53: 9.0	↘
54: 9.5	→
55: 8.6	←
56: 8.7	←
57: 10.0	→
58: 10.0	↘
59: 8.8	↘
60: 9.9	←
Series	93.8
Total	574.7

Relay 1	Lane 16	Jone Lång	
-------------------	-------------------	------------------	--

Air	KaA	AR Y18
-----	-----	--------

8.-9.2014	Kevätkilpailut	Kankaanpään Ampumaurheilijat
-----------	----------------	------------------------------

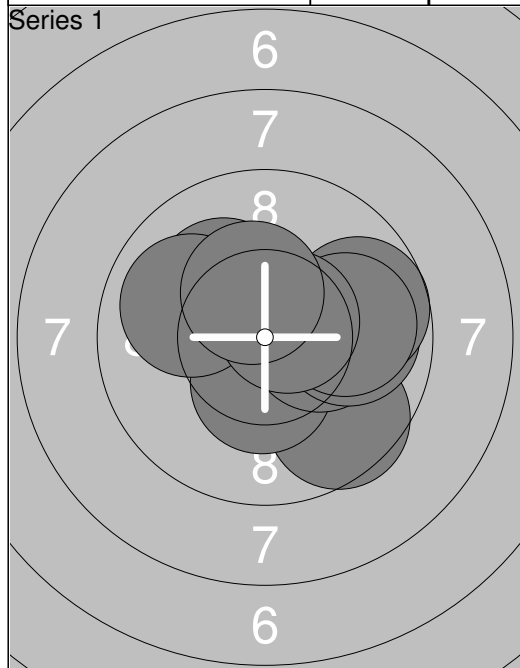

1:	9.6	↘
2:	10.2x	↗
3:	10.4x	↓
4:	10.0	↖
5:	10.3x	→
6:	9.9	→
7:	9.7	→
8:	10.0	→
9:	10.6x	↗
10:	10.4x	↗
Series	101.1	
Total	101.1	

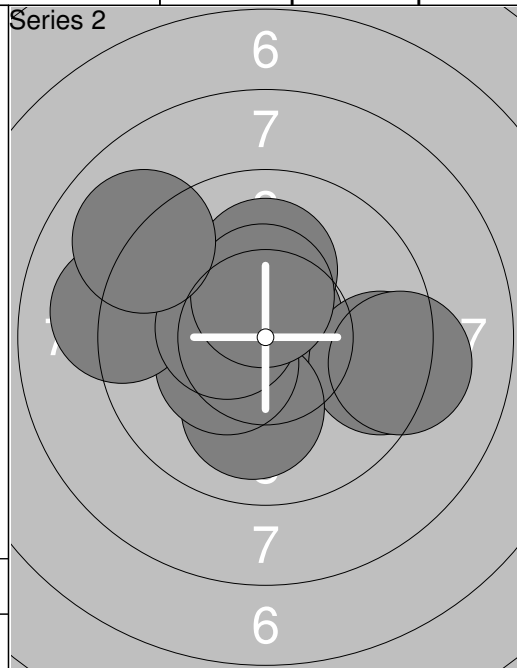

11:	10.7x	↗
12:	9.5	→
13:	10.1	↓
14:	10.4x	↙
15:	10.1	↑
16:	9.1	↖
17:	9.3	→
18:	10.5x	↖
19:	10.4x	↑
20:	9.0	↖
Series	99.1	
Total	200.2	

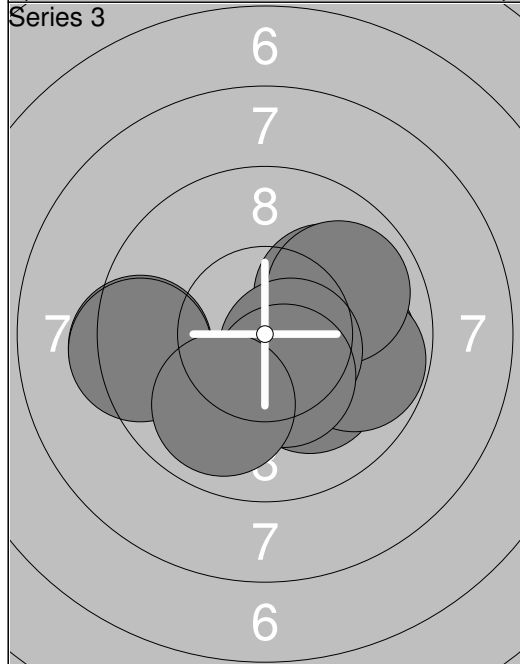

21:	10.1	↘
22:	10.0	↗
23:	9.9	→
24:	9.8	→
25:	9.9	↗
26:	9.4	↖
27:	10.6x	↘
28:	9.4	↖
29:	10.4x	↓
30:	9.9	↘
Series	99.4	
Total	299.6	

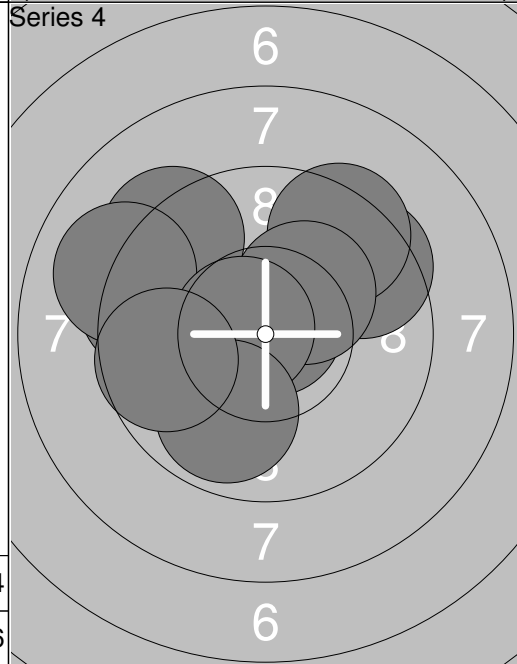

31:	9.5	↗
32:	10.8x	↗
33:	9.4	↗
34:	9.5	↖
35:	9.3	↖
36:	9.0	↖
37:	10.2x	↗
38:	10.6x	↖
39:	9.9	↓
40:	9.7	↖
Series	97.9	
Total	397.5	

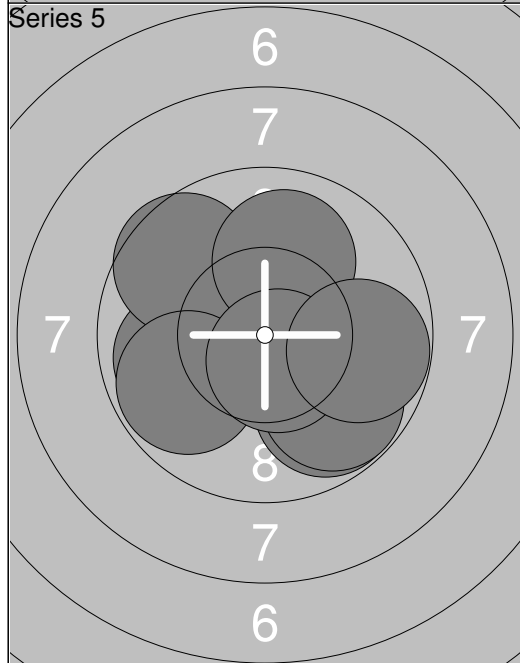

41:	9.9	↖
42:	10.4x	↓
43:	10.2x	→
44:	9.6	↗
45:	10.0	↑
46:	9.8	↓
47:	9.8	↓
48:	9.8	↖
49:	10.6x	↓
50:	9.8	→
Series	99.9	
Total	497.4	

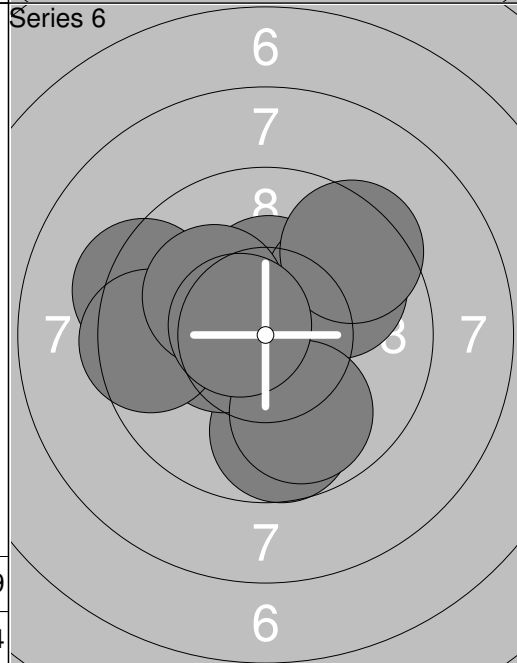

51:	9.3	↖
52:	10.4x	↑
53:	9.7	↓
54:	10.4x	↖
55:	9.9	↗
56:	9.9	↓
57:	9.5	↖
58:	9.5	↗
59:	10.1	↖
60:	10.6x	↖
Series	99.3	
Total	596.7	

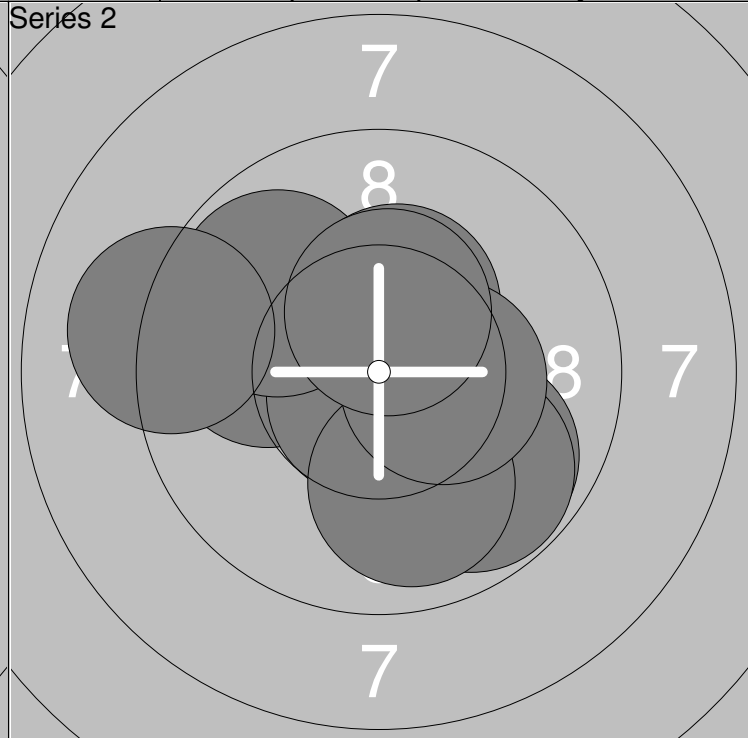
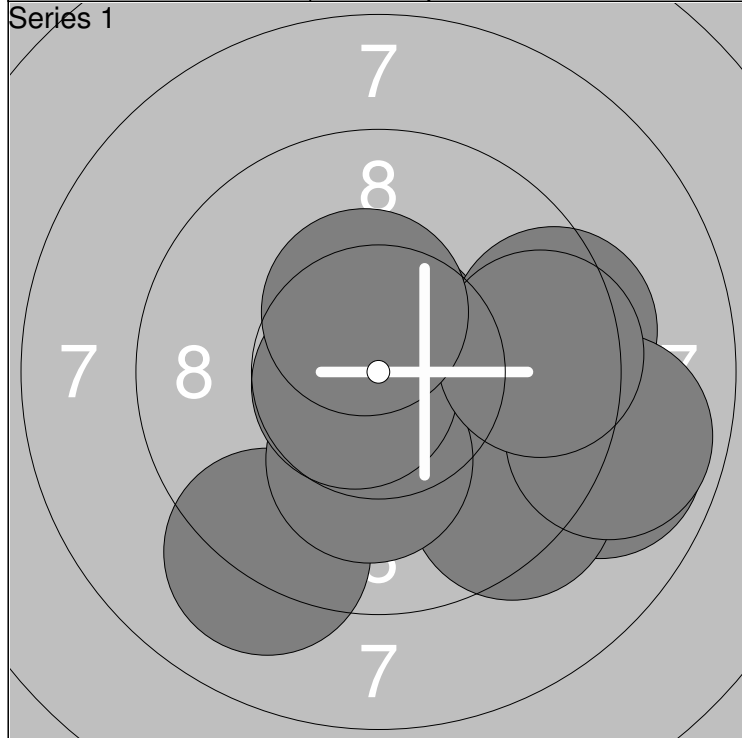

1: 9.1 ↘	6: 10.2x ↓	Series 97.2
2: 8.9 →	7: 10.7x ↙	
3: 9.4 ↘	8: 8.9 →	Total 97.2
4: 10.7x ↑	9: 9.5 →	
5: 9.4 →	10: 10.4x ↑	

11: 10.0 ←	16: 9.8 ↘	Series 100.4
12: 10.7x ↓	17: 10.4x ↑	
13: 9.8 ↗	18: 9.9 ↓	Total 197.6
14: 9.1 ←	19: 10.4x →	
15: 9.9 ↘	20: 10.4x ↑	

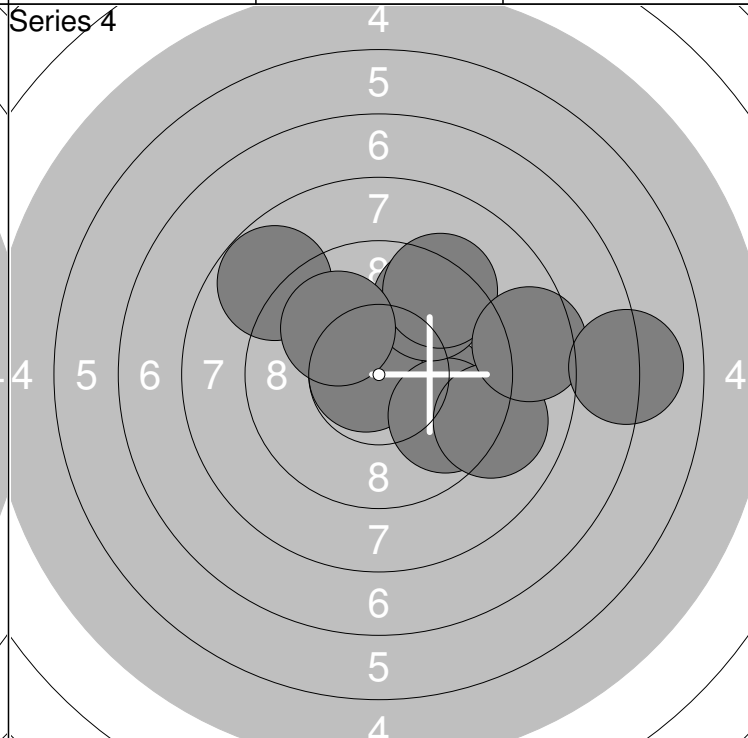
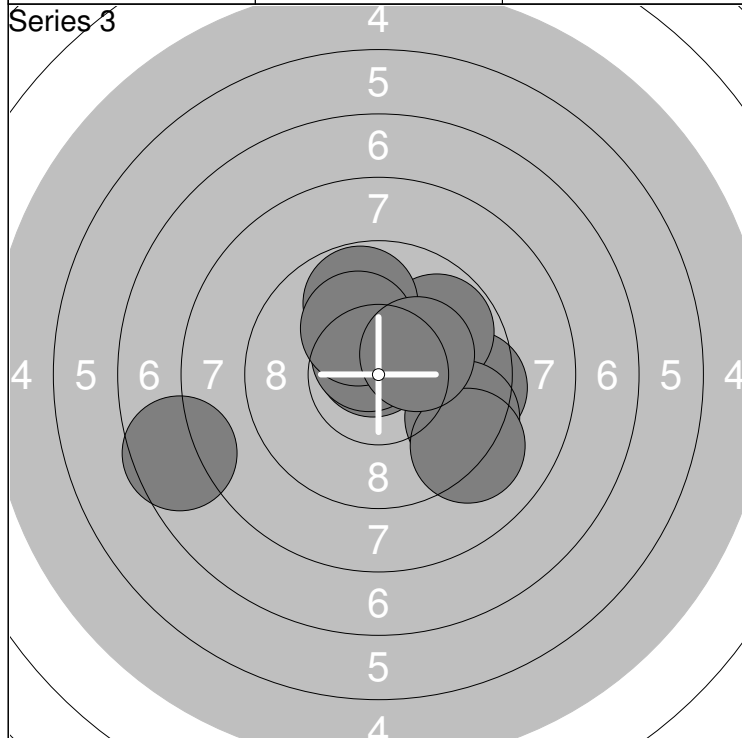

21: 9.5 →	26: 9.8 ↑	Series 97.1
22: 10.7x ↑	27: 9.2 ↘	
23: 10.6x ↑	28: 7.6 ←	Total 294.7
24: 9.8 ↗	29: 10.2x ↑	
25: 9.5 ↘	30: 10.2x ↗	

31: 10.1 →	36: 8.8 ↖	Series 93.0
32: 10.8x ←	37: 9.3 ↗	
33: 9.7 ↘	38: 8.5 →	Total 387.7
34: 9.1 →	39: 10.0 ↖	
35: 9.6 ↗	40: 7.1 →	

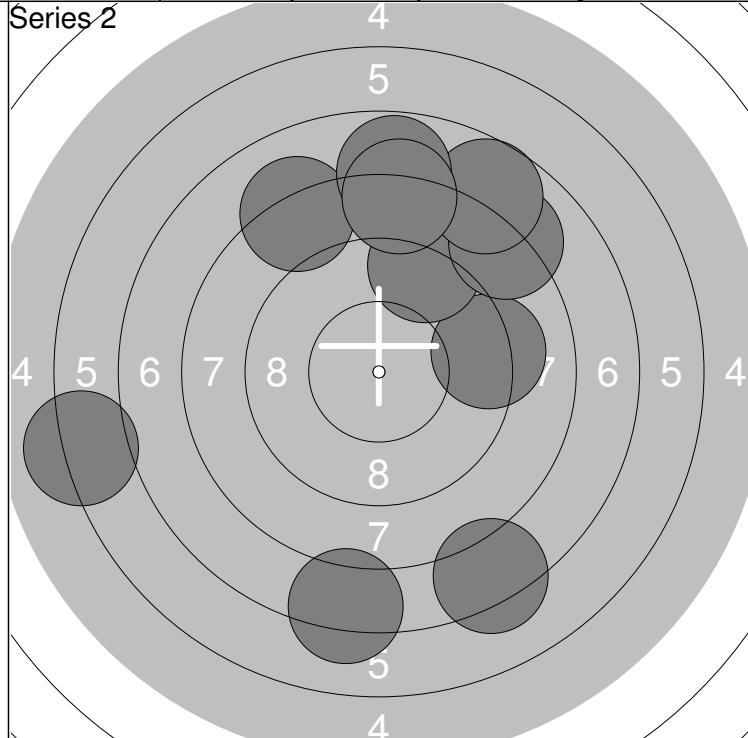
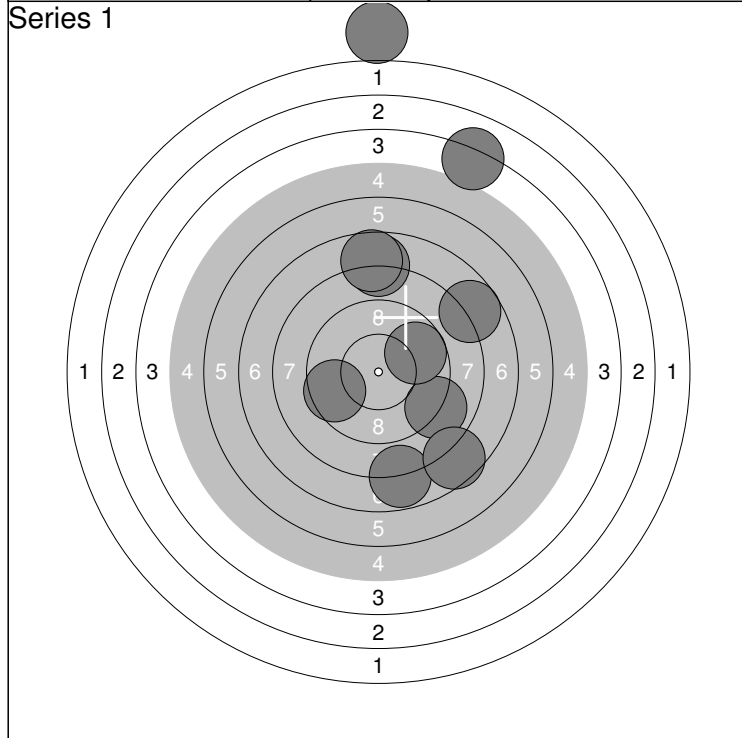

1: 7.7 ↗	6: 9.7 ↗	Series	72.0
2: 7.9 ↓	7: 1.0 ↑		
3: 9.0 ↘	8: 9.5 ←	Total	72.0
4: 7.8 ↑	9: 7.7 ↑		
5: 4.1 ↗	10: 7.6 ↘		

11: 9.2 →	16: 8.1 ↗	Series	78.9
12: 8.2 ↖	17: 7.7 ↗		
13: 9.1 ↗	18: 7.8 ↑	Total	150.9
14: 7.2 ↓	19: 7.3 ↘		
15: 6.1 ←	20: 8.2 ↑		

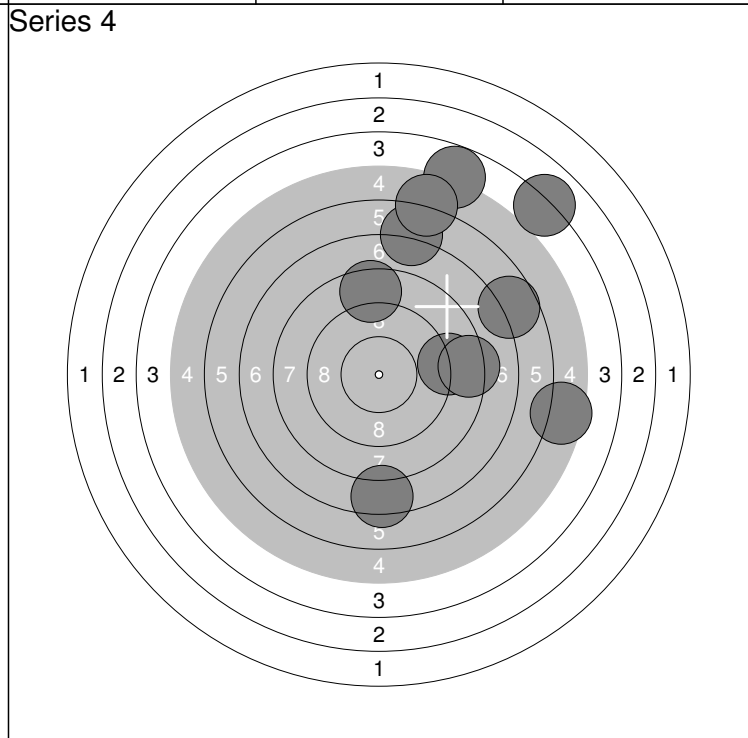
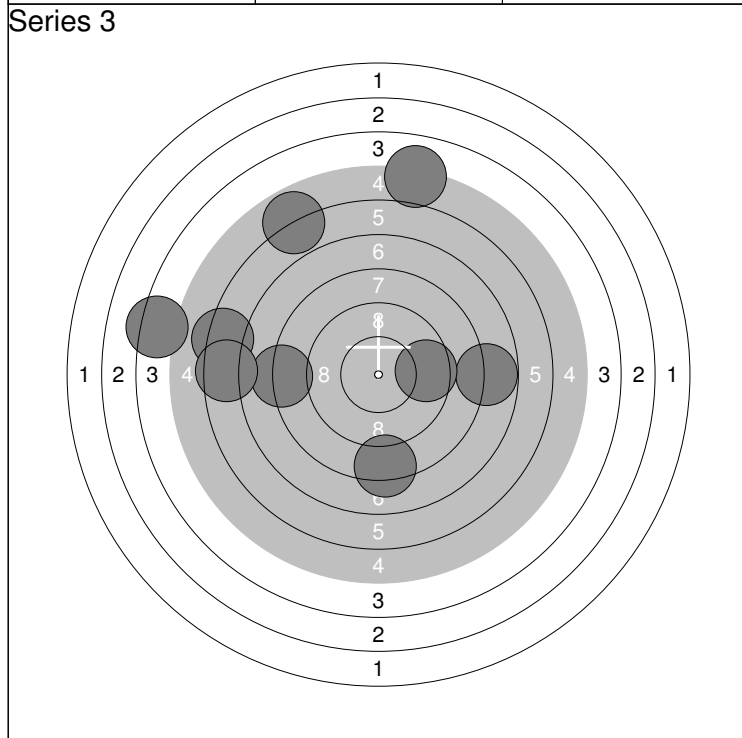

21: 7.8 →	26: 8.3 ↓	Series	61.8
22: 0.0 →	27: 6.3 ←		
23: 8.1 ←	28: 9.5 →	Total	212.7
24: 4.3 ←	29: 6.5 ←		
25: 5.9 ↗	30: 5.1 ↑		

31: 4.0 ↗	36: 5.5 →	Series	66.6
32: 8.5 ↑	37: 7.4 ↓		
33: 6.7 ↑	38: 4.8 ↗	Total	279.3
34: 8.9 →	39: 8.3 →		
35: 6.7 ↗	40: 5.8 ↑		

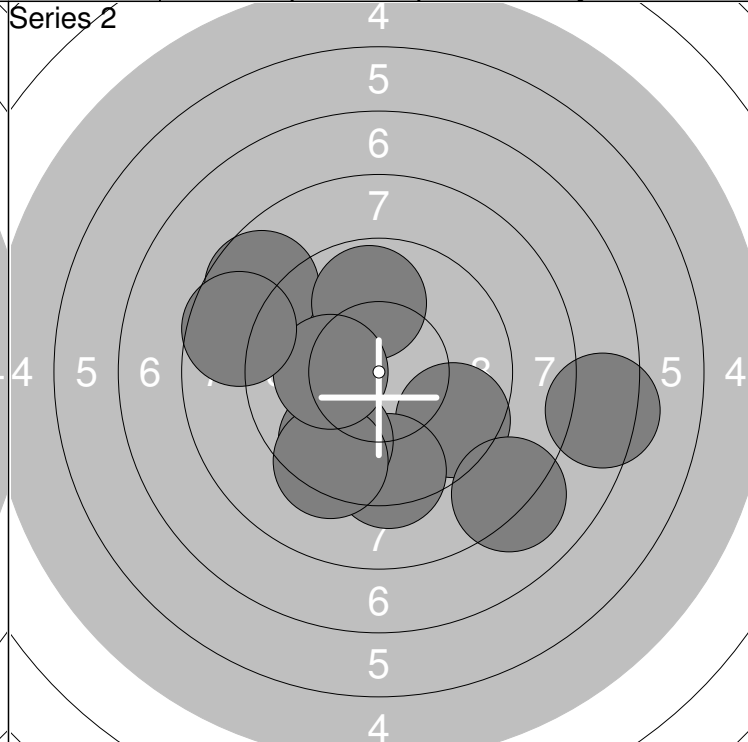
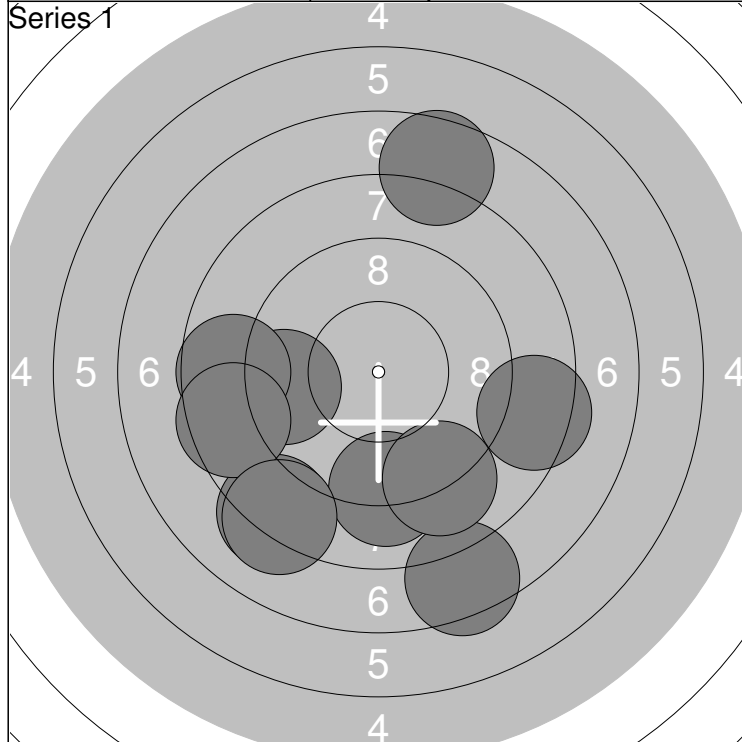

1: 8.4 →	6: 7.6 ↑	Series	84.7
2: 9.4 ←	7: 8.2 ↓		
3: 9.1 ↓	8: 8.6 ←	Total	84.7
4: 8.7 ←	9: 8.2 ↓		
5: 7.5 ↓	10: 9.0 ↓		

11: 8.7 ↗	16: 9.7 ↓	Series	91.0
12: 9.6 ↓	17: 9.3 ↓		
13: 8.2 ↓	18: 10.2x ←	Total	175.7
14: 9.8 ↑	19: 7.4 →		
15: 9.4 ↓	20: 8.7 ←		

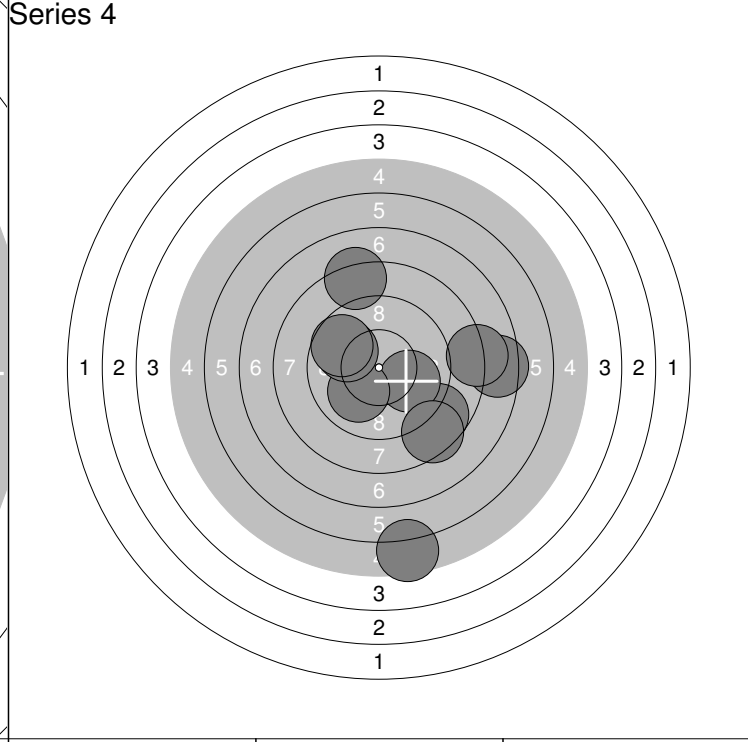
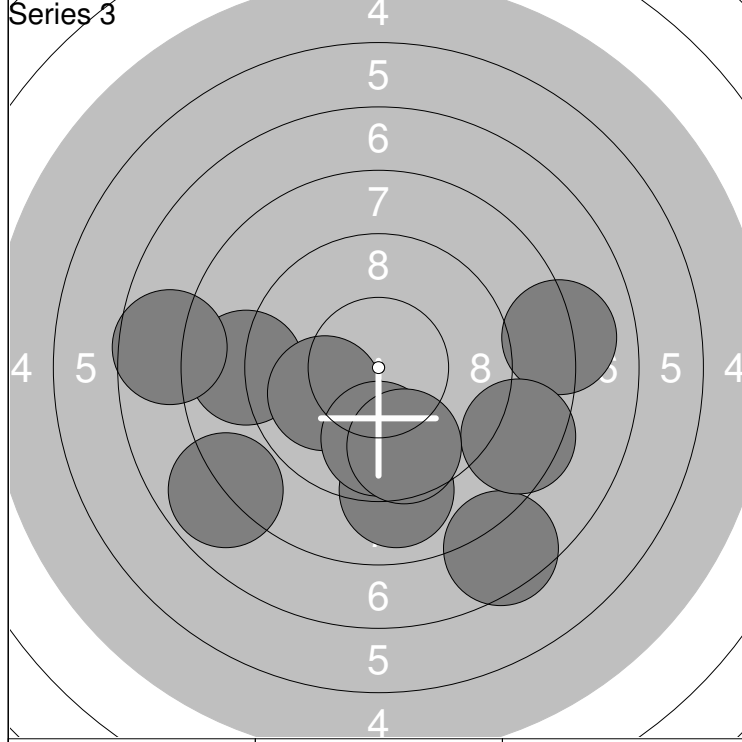

21: 8.9 ←	26: 10.0 ←	Series	86.9
22: 7.6 ←	27: 9.8 ↓		
23: 9.0 ↓	28: 8.1 →	Total	262.6
24: 7.5 ↓	29: 8.5 →		
25: 7.9 ↙	30: 9.6 ↓		

31: 5.5 ↓	36: 7.5 →	Series	86.4
32: 8.8 ↓	37: 9.9 ↖		
33: 10.0 →	38: 9.7 ↖	Total	349.0
34: 10.1 ↙	39: 8.3 ↑		
35: 8.5 ↓	40: 8.1 →		